



Accessoires

# Accessories

## 2018

EN

FR



1894

**GIRARD SUDRON**

Créateur de Lumière



### Dear customers,

Lighting equipment components are Girard Sudron's core products, the ones that got us started in this business. Over the years, we have created a wide, diversified product range that is unique on the market.

For the past few years, this sector has suffered due to many issues, including technological changes, fewer European manufacturers, disaffection for restoring old lighting, lack of innovation and more.

We invite you to explore the pages of this catalogue, which offers revitalisation, a selection decidedly focused on decorative products, thus preserving our creative tradition.

Tradition also entails preservation, which means you will find essential lighting components along with the latest new trends. No matter what the style, every product features the Girard Sudron quality you rely on.

Our team spent many months on this background work, which is a new starting foundation that will be expanded based on the needs, trends, innovations, and new products that you will need for your work.

We are thrilled to present this new collection and look forward to your feedback so we can expand it to meet your future needs.

The Girard Sudron team

### Chères clientes, chers clients,

Fer de lance de notre entreprise, produits à l'origine de notre création, les composants d'équipement lumière ont constitué chez Girard Sudron au fil des ans une offre produit large et diversifiée, unique sur le marché.

Depuis quelques années, cette gamme a souffert sur de nombreux aspects : mutation technologique, diminution des fabricants européens, désaffection pour la restauration des luminaires anciens, manque d'innovation, etc.

Au travers des pages que nous vous invitons à découvrir, nous vous proposons le renouveau par la mise en place d'une orientation produit résolument plus décorative, conservant ainsi notre tradition créatrice.

Qui dit tradition, dit également conservation. Vous pouvez ainsi retrouver les composants lumières indispensables, qui viendront accompagner les dernières nouveautés tendances, le tout conservant la qualité Girard Sudron.

Ce travail de fond, réalisé sur de nombreux mois par nos équipes, constitue un nouveau socle de départ, lequel viendra s'enrichir au gré des besoins, des tendances et des innovations, des nouveautés qui vous seront indispensables pour créer.

Nous sommes ravis de vous présenter cette nouvelle collection et restons attentif pour la compléter de vos futurs besoins,

L'équipe Girard Sudron

### Sehr geehrte Kunden, sehr geehrter Kunde,

Komponenten für Beleuchtungslösungen sind schon seit jeher der Schwerpunkt und die Zielrichtung unseres Unternehmens, die zu seiner Gründung führten. Im Laufe der Jahre hat Girard Sudron eine große, vielfältige Produktpalette entwickelt, die auf dem Markt einmalig ist.

In den letzten Jahren hatte sie jedoch in mehrfacher Hinsicht zu leiden: technologischer Wandel, Verschwinden von europäischen Herstellern, nachlassendes Interesse an der Restaurierung von alten Leuchten, zu wenig Innovation usw.

Wir laden Sie ein, sich in diesem Katalog ein Bild von unserer neuen Dynamik zu machen, die auf einer entschieden dekorativeren Ausrichtung der Produkte beruht und gleichzeitig unsere kreative Tradition bewahrt.

Tradition geht fest mit Bewahrung einher. Entdecken Sie unverzichtbare Komponenten für Beleuchtungslösungen (wieder), die mit den aktuellsten Trends bereichert wurden und sich durch die bewährte Qualität von Girard Sudron auszeichnen.

Für uns ist diese Grundlagenarbeit, der unsere Teams viele Monate gewidmet haben, ein neuer Start. Zukünftig werden wir unsere Produkte zielgerichtet an den Bedarf, die Trends, die Innovationen und die Neuheiten anpassen, die Sie für Ihre kreativen Projekte brauchen.

Wir freuen uns, Ihnen diese neue Kollektion präsentieren zu können, und werden die Entwicklungen des Marktes genau im Auge behalten, um unser Angebot fortlaufend an Ihren Bedarf anzupassen.

Das Team von Girard-Sudron

### Gentili clienti,

Con il passare del tempo | componenti per gli impianti di illuminazione, fulcro iniziale e a lungo fiore all'occhiello dell'attività di Girard Sudron, hanno costituito un'offerta ampia e diversificata, unica sul mercato.

Negli ultimi anni, tuttavia, questa gamma di prodotti ha sofferto per svariati motivi : mutazione tecnologica, diminuzione dei produttori europei, rimozione per restauro, mancanza d'innovazione, ecc.

Nelle pagine del presente catalogo ti invitiamo a scoprire articoli dall'impostazione decisamente nuova che, diventando veri e propri complementi d'arredo, mantengono intatta tutta la nostra tradizione creativa.

Si sa, tradizione fa rima con conservazione. Nel catalogo, quindi, accanto alle ultime novità in fatto di tendenza, troverai anche | classici elementi indispensabili per qualsiasi tipo d'impianto, il tutto realizzato con la qualità che da sempre contraddistingue Girard Sudron.

Questo importante lavoro di fondo, che ha richiesto diversi mesi di intensa attività ai nostri team, rappresenta una nuova base di partenza che si arricchirà secondo le esigenze, le tendenze, le innovazioni e le novità di cui avrai bisogno in futuro per creare.

Per tutti questi motivi siamo davvero lieti di presentare la nostra nuova collezione e faremo sempre in modo di completarla di volta in volta seguendo le tue esigenze del momento. Buona consultazione,

Lo staff di Girard Sudron

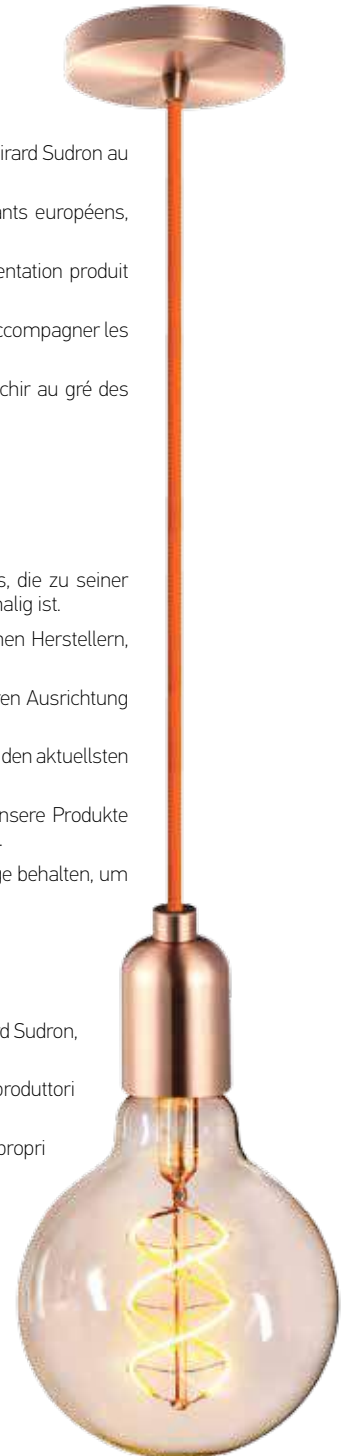

# SUMMARY

<b>DO IT YOURSELF (DIY)</b> .....	<b>11</b>	<b>CABLES &amp; CORDS</b> .....	<b>87</b>
Suspensions	12	Flat textile cables	88
Suspensions.....	12	Câbles textile méplat.....	88
Porcelain fixtures	16	Round textile cables	88
Appliques porcelaine.....	16	Câble textile rond.....	88
Ceiling roses	18	Flat PVC Cables	90
Rosaces.....	18	Câbles PVC méplat.....	90
Cables	23	Round PVC cables	90
Câbles.....	23	Câbles PVC rond.....	90
Lampholders	28	Twisted textile cables	92
Douilles.....	28	Câbles textile torsadé.....	92
Pair of steel cover plates	37	Oval PVC cables	96
Paire de disques acier.....	37	Câbles PVC ovale.....	96
Metal shades	38	UL cables for USA	97
Abat-jours métal.....	38	Câbles UL pour USA.....	97
<b>SUSPENSIONS - ECOWATTS</b> .....	<b>43</b>	High temperature cable	97
Suspensions	44	Câble haute température.....	97
Suspensions.....	44	Plastic power cords	
Ceiling cups	47		
Pavillons.....	47		
<b>LAMPHOLDERS</b> .....	<b>49</b>		
Assembled lampholders E27	50		
Douilles montées E27.....	50		
Non-assembled lampholders E27	54		
Douilles démontées E27.....	54		
Assembled lampholders E14	57		
Douilles montées E14.....	57		
Non-assembled lampholders E14	61		
Douilles démontées E14.....	61		
Rings for E27 lampholders	64		
Bagues pour douilles E27.....	64		
Rings for E14 lampholders	65		
Bagues pour douilles E27.....	65		
Non-assembled lampholders E26	66		
Douilles démontées E26.....	66		
Non-assembled lampholders E12	67		
Douilles démontées E12.....	67		
Assembled lampholders E27 with earth	68		
Douilles E27 montées chemise fileté avec la terre.....	68		
Large rings for E27 lampholders	68		
Grandes bagues pour douilles E27.....	68		
Assembled lampholders E14 with earth	69		
Douilles E14 montées chemise fileté avec terre.....	69		
Large rings for E14 lampholders	69		
Grandes bagues pour douilles E14.....	69		
Transparent lampholders E14	70		
Douilles transparentes E14.....	70		
Smart touch E27 lampholder with dimmer	70		
Douille E27 avec variateur LED sensitive.....	70		
Brass bayonet cap lampholders B15 - B22	71		
Douilles à baïonnette en laiton B15 - B22.....	71		
Brass-plated steel lampholders E14/E27	74		
Douilles en acier laitonné E14/E27.....	74		
Porcelain lampholders	75		
Douilles en porcelaine.....	75		
R7S lampholders	77		
Douilles avec étrier.....	77		
Lampholders for "linolite" lamps	79		
Douilles linolites.....	79		
Accessories for low voltage lampholders	81		
Accessoires pour douilles à basse tension.....	81		
		Cordons plastique.....	99
		Textile power cords	104
		Cordons textile.....	104
		Power cord with dimmer	105
		Cordon avec variateur.....	105
		Transparent heat-shrink sheath	106
		Gaîne thermo-retractable transparente.....	106
		High temperature sheath	106
		Gaîne haute température.....	106
		Wire stripper	107
		Pince à dénuder.....	107
		<b>SWITCHES &amp; PLUGS</b> .....	<b>109</b>
		Bipolar switches	110
		Interrupteurs bipolaires.....	110
		Pushbutton switches	113
		Interrupteurs à poussoir.....	113
		Pull switch	114
		Interrupteur unipolaire à tirette.....	114
		Unipolar rocker switches	114
		Interrupteurs unipolaires à bascule.....	114
		Foot switches	115
		Interrupteurs à pied avec terre.....	115



Toggle switch	
Interrupteur tumbler.....	115
Conical rings for pushbutton switches	
Bagues coniques pour interrupteurs à poussoir.....	116
Foot dimmers	
Variateur à pied.....	117
Hand dimmers	
Variateur à main.....	119
Contactors	
Contacteurs.....	121
Male plugs	
Fiches mâles.....	122
Bipolar plugs + Earth	
Fiches bipolaires + Terre.....	123
6 outlet extension cord	
Socle prolongateur 6 prises aluminium.....	124
Multi sockets	
Bloc multiprises.....	124
Plugs	
Fiches.....	125
Adaptors plugs EU - UK	
Adaptateurs de fiches EU - UK.....	126
Dimmers	
Variateurs.....	127
Universal adaptor EU - UK - USA + 2 USB	
Adaptateur universel.....	128
Connection device for lights	
Dispositif de connexion pour luminaire.....	128
Infrared motion sensors	
Détecteurs de présence à infrarouges.....	129

## ADAPTORS.....133

Adaptors	
Adaptateurs.....	134

## DRIVERS.....137

Halogen drivers	
Convertisseurs halogène.....	138
LED & Halogen drivers	
Convertisseurs LED et Halogène.....	141
LED drivers	
Convertisseurs LED.....	142

## METALLIC PARTS FOR LIGHTING.....147

S - hooks	
Esses.....	148
Clapper rings	
Bélières.....	148
Slip rings	
Bagues coulissantes.....	149
Looped stems with cable passage	
Tubes pour pavillons.....	149
Ceiling cups	
Pavillons.....	149
Chains	
Chaînes.....	151
Loops	
Anneaux.....	152
Accessories for lampshades	
Accessoires pour griffes.....	153
Threaded tubes	
Tubes filetés.....	155
Small threaded tubes	
Tubulures filetées.....	156
Smooth tube	
Tube lisse.....	157
6 sided nuts	
Ecrou 6 pans.....	158
Washers	
Rondelles.....	158
Bushings with flange	
Raccords à portée.....	160



Double female couplings	
Raccords double femelle.....	161
Male & female bushing	
Raccord mâle et femelle.....	161
Reduction nipples	
Raccords de réduction.....	162
Soldering bushes	
Raccords à souder.....	162
Hickeys	
Raccords étrier.....	162
Nipples on thin plate	
Raccords à lame.....	163
Finials	
Raccords fin de lustre.....	163
Top & side threaded bushings	
Raccords équerre.....	164
Bushings on plate	
Raccords à plaque.....	164
Ball with rod	
Boule à tige.....	165
Candle cup	
Bobèche.....	165
Lampholder covers	
Cache-douilles.....	166
Pan	
Coupelle.....	166
Swivels	
Rotules.....	167
Plier	
Pince.....	169
Pipes	
Chandelles.....	169
Extension tubes	
Tubes rallonge.....	171
Adaptators	
Talons.....	172

Sliding pipes	
Tubes coulissant.....	173
Bushing	
Embase.....	173
Acorn	
Gland.....	174
Turned nipple	
Filet décollété.....	174
Cluster bodies	
Boîtes nourrice.....	174
Bi-plates	
Bilames.....	175
Coupling with side hole for wire	
Raccord passage de câble.....	176



Rigid plates	
Lames rigides.....	176
Covers	
Dessus.....	177

## FITTING ACCESSORIES.....179

Fitting Accessories	
Accessoires d'équipements.....	180
Grommets	
Passe-fils.....	185
Cable clamps	
Arrêts de traction.....	186
Adaptor rings E27 / E14 - B22	
Bagues de réduction E27 / E14 - B22.....	187
Two-lamp housing	
Boîtier bilampe.....	187
Connectors	
Connecteurs.....	187
Connector blocks	
Bornes de connexion.....	188
Pre-insulated terminal ends with insulation sleeve	
Raccords embouts pré-isolés.....	194
Pre-insulated cable lug	
Cosse à sertir pré-isolées.....	195
Butt and parallel connector	
Connecteur en série.....	195
Terminal blocks	
Domino bornes.....	195
Recessed fittings	
Enjoliveurs orientables.....	196
Reflectors	
Réflecteurs.....	198

## GLASSWARES.....201

Shade adaptors & lampshades for E27 lampholders	
Griffes de suspensions et verreries pour douille E27.....	202
Electric oil lamp burners	
Becs pour lampes pétrole électriques.....	204
Glasswares for Mazda lamps	
Verreries pour lampes Mazda.....	205
Glass lampshades for oil lamps	

Verreries pour lampes à pétrole.....	205
Accessories for oil lamps	
Accessoires pour lampes à pétrole.....	208
Vesta glasswares	
Verreries Vesta.....	209
Satin etched globes "Louis XV" style	
Globes satinés gravure style « Louis XV ».....	210
Glass lampshades	
Suspensions en verre.....	211
"Empire" style candle glasswares	
Verreries flamme style « Empire ».....	211
Tulip glasswares	
Verreries tulipe.....	212
Vintage style "Épi" tulip glasswares	
Verreries tulipe « Épi » style vintage.....	212
"Art Deco" style tulip glasswares	
Verreries tulipe style « Art Déco ».....	213
"Art Deco" style dome glassware	
Verrerie dôme style « Art Déco ».....	213
Opale lampshades	
Abat-jours opales.....	214
Opale globes	
Globes opales.....	214
Tulip shades for chandeliers	
Tulipes pour lustres.....	215
Satin etched globes for chandeliers	
Globes satinés gravés pour lustres.....	217
Accessories for chandeliers	
Accessoires pour lustres.....	217
Wall lamps "Swan Neck"	
Appliques « Col de cygne ».....	217

## FALSE CANDLES.....219

Candle sleeves without drips	
Fourreaux sans gouttes.....	220
Candle sleeve without drips in opal glass	
Fourreau sans gouttes en verre opale.....	220
Candle sleeves with drips	
Fourreaux avec gouttes.....	221
Candle lampholders E14	
Supports bougies E14.....	221
Candle sleeves with drips	
Fourreaux avec gouttes.....	224
Candle sleeve without drips	
Fourreau sans gouttes.....	225
Candles "Grand siècle" The classics	
Bougies « Grand siècle » Les classiques.....	226
Candles "Grand siècle" The modern	
Bougies « Grand siècle » Les modernes.....	226
Candle "La Vacillante"	
Bougie « La Vacillante ».....	228
"Vivaflam" candle	
Bougie « Vivaflam ».....	228

## BELT LIGHTS.....231

Belt lights	
Guirlandes lumineuses.....	233
LED Light bulbs	
Ampoules LED.....	234
Metallic lampshades	
Abat-jours métalliques.....	236

## SUMMARY OF REFERENCES.....238

## TERMS AND CONDITIONS.....244



Product photos and information are for illustration purposes only. Detailed information provided by the sales department upon request. Certifications and declarations of conformity are available on our website and established upon request. Standards for each product are indicated in the declarations of conformity.

Les photographies et informations des produits présentés sont non contractuelles, se référer aux informations fournies par le service commercial sur demande. Les certifications et déclarations de conformité sont disponibles sur le site internet et établies à la demande. Les normes de chacun des produits sont indiquées dans les déclarations de conformité.

# Our symbols

Nos symboles

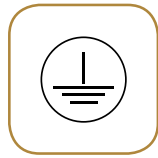

Class 1  
Classe 1

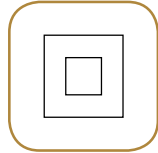

Class 2  
Classe 2



Consumer Sales Unit  
Unité de vente consommateur



Bag  
Sachet



SEV  
Suisse  
Switzerland



UL



ENEC  
Electrical Certification  
Normes Européennes



cURus

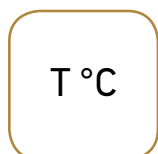

Operating temperature  
Température de fonctionnement



Guarantee  
Garantie



Ingress protection  
Indice de protection

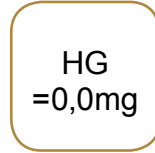

Quantity of Mercury  
Quantité de mercure



Dimmable with dimmer  
Utilisation possible avec un variateur



Non dimmable

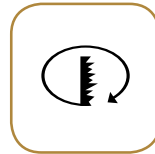

Cutting diameter  
Encastrement

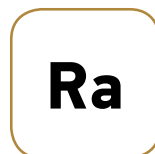

Colour Rendering Index  
Indice de rendu des couleurs



Beam angle  
Angle de diffusion



Switching cycle  
Cycle de commutation



Lifespan  
Durée de vie

Voltage  
Tension

V. AC  
110 - 240V  
50/60Hz

V. AC  
220 - 240V  
50/60Hz



# Our symbols

Nos symboles

---



**Instant Lighting**  
Eclairage instantané



**Energy Scale**  
Echelle énergétique



**CE "European Conformity"**  
Norme CE "conformité européenne"



**Recyclable**  
Produits recyclables



**RoHS "Restriction of Hazardous Substances"**  
Norme RoHS "restriction de l'utilisation de certaines substances dangereuses dans les équipements électriques et électroniques"



# DIY



# Concrete suspensions E27 (metal ceiling rose, textile cable L. 200cm)

Suspensions béton, pavillon métal et câble textile

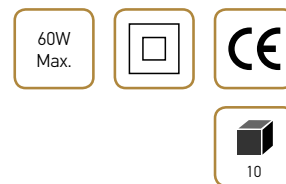
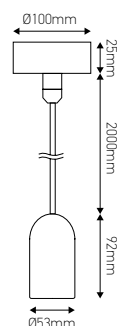

## Description

- Cable section | Section du câble : 2 x 0.75mm<sup>2</sup>
- Cable type | Type de câble : H03VV-F
- Material | Matériau
  - Ceiling rose | Pavillon : Steel | Acier
  - Socket | Douille : Concrete | Béton



Ø110 x 125mm

# Porcelain suspensions E27 (textile cable L. 200cm)

Suspensions porcelaine câble textile

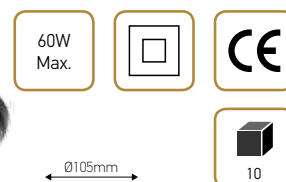
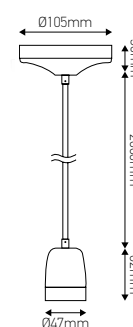

## Description

- Cable section | Section du câble : 2 x 0.75mm<sup>2</sup>
- Cable type | Type de câble : H03VV-F
- Material | Matériau
  - Ceiling rose | Rosace : Porcelain | Porcelaine
  - Socket | Douille : Porcelain | Porcelaine



Ø110 x 100mm

# Porcelain suspensions E27 (textile cable L. 100cm)

Suspensions porcelaine câble textile



60W Max.

CE

10

### Description

- Cable section | Section du câble : 2 x 0.75mm<sup>2</sup>
- Cable type | Type de câble : H03VV-F
- Material | Matériau
  - Ceiling rose | Rosace : Porcelain | Porcelaine
  - Socket | Douille : Porcelain | Porcelaine



Ø110 x 100mm

# Metal suspension E27 (textile cable L.200cm)

Suspension métallique câble textile

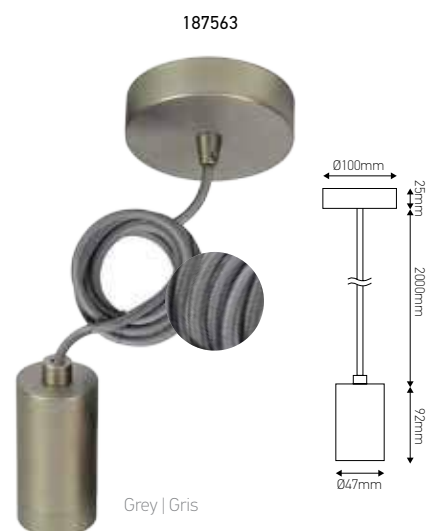

60W Max.

CE

10

### Description

- Cable section | Section du câble : 2 x 0.75mm<sup>2</sup>
- Cable type | Type de câble : H03VV-F
- Material | Matériau
  - Ceiling rose | Pavillon : Steel | Acier
  - Socket cover | Cache-douille : Aluminium
  - Lampholder | Douille : Plastic | Plastique

### Application

Can be installed with a lampshade or glassware  
Peut être utilisé avec un abat-jour ou une verrerie



Ø110 x 125mm

# Metal suspension E27 with threaded lampholder (textile cable L. 200cm)

Suspension métallique avec douille filletée câble textile

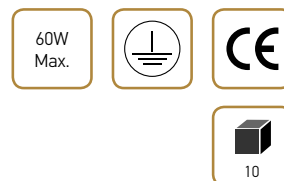

### Description

- Cable section | Section du câble : 2 x 0.75mm<sup>2</sup>  
 Cable type | Type de câble : H03VV-F  
 Material | Matériau
- Ceiling rose | Pavillon : Steel | Acier
  - Socket cover | Cache-douille : Aluminium
  - Lampholder | Douille : Plastic | Plastique

### Application

Can be installed with a lampshade or glassware  
 Peut être utilisé avec un abat-jour ou une verrerie



Ø110 x 100mm

# Metal suspensions E40/E27 (textile cable L. 200cm)

Suspensions métalliques câble textile

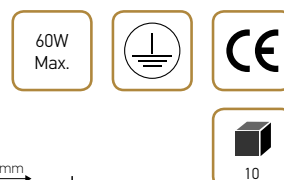
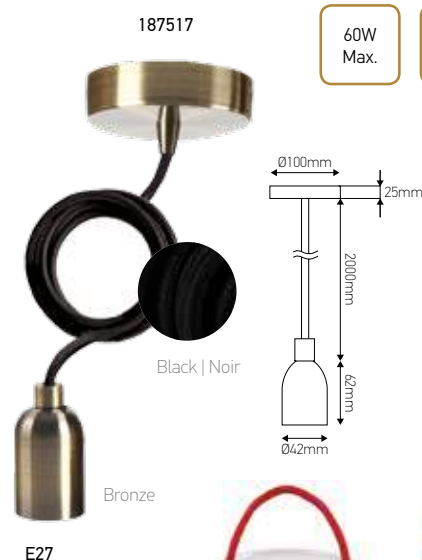
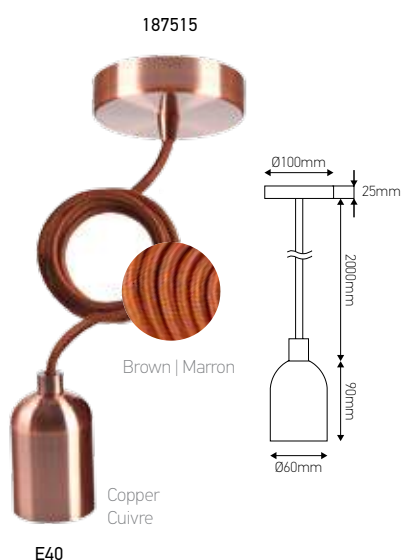

### Description

- Cable section | Section du câble : 2 x 0.75mm<sup>2</sup>  
 Cable type | Type de câble : H03VV-F  
 Material | Matériau
- Ceiling rose | Pavillon : Steel | Acier
  - Socket cover | Cache-douille : Aluminium
  - Lampholder | Douille : Ceramic | Céramique

### Description

- Cable section | Section du câble : 2 x 0.75mm<sup>2</sup>  
 Cable type | Type de câble : H03VV-F  
 Material | Matériau
- Ceiling rose | Pavillon : Steel | Acier
  - Socket cover | Cache-douille : Aluminium
  - Lampholder | Douille : Plastic | Plastique



Ø110 x 150mm



Ø110 x 100mm

# Metal suspensions E27 with threaded lampholders (textile cable L. 100cm)

Suspensions métalliques avec douille filletée câble textile

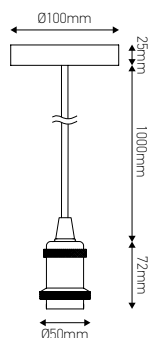

60W Max.

10

### Description

- Cable section | Section du câble : 2 x 0.75mm<sup>2</sup>
- Cable type | Type de câble : H03VV-F
- Material | Matériau
  - Ceiling rose | Pavillon : Steel | Acier
  - Socket cover | Cache-douille : Aluminium
  - Lampholder | Douille : Plastic | Plastique

### Application

Can be installed with a lampshade or glassware  
Peut être utilisé avec un abat-jour ou une verrerie



Ø110 x 100mm

# Metal suspension E27 (textile cable L. 100cm)

Suspension métallique câble textile

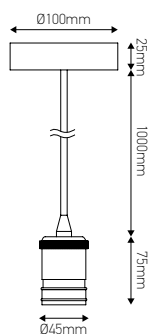

60W Max.

10

### Description

- Cable section | Section du câble : 2 x 0.75mm<sup>2</sup>
- Cable type | Type de câble : H03VV-F
- Material | Matériau
  - Ceiling rose | Pavillon : Steel | Acier
  - Socket cover | Cache-douille : Aluminium
  - Lampholder | Douille : Plastic | Plastique



Ø110 x 100mm

# Silicone suspensions E27 (silicone cable L. 80cm)

Suspensions silicone câble silicone

241878



Red | Rouge

241879



Black | Noir

241880



White | Blanc

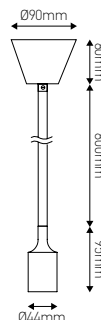

## Description

Cable section | Section du câble : 2 x 0.75mm<sup>2</sup>

Cable type | Type de câble : H05SS-F

Material | Matériau

- Ceiling rose | Pavillon : Polypropylène | Polypropylène
- Socket cover | Cache-douille : Silicon | Silicone
- Lampholder | Douille : Plastic | Plastique



Ø110 x 125mm

# Porcelain fixtures E27

Appliques porcelaine

167510



Black | Noir

167511



White | Blanc

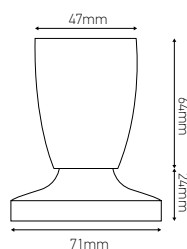

EN 60598-2-1:1989  
used in conjunction with  
EN 60598-1:2015  
EN 62031:2008+A1: 2013+A2:2015  
EN 62471:2008

## Description

Cable section | Section du câble : 2 x 0.75mm<sup>2</sup>

Cable type | Type de câble : H05V-K



72 x 72 x 87mm



# Porcelain fixtures E27 with flexible tube

Appliques porcelaine tube flexible

167512

167513



Black | Noir



White | Blanc

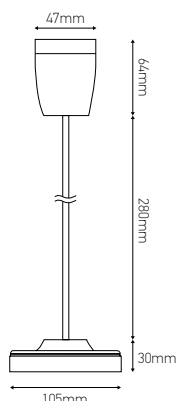

EN 60598-2-1:1989  
used in conjunction with  
EN 60598-1:2015  
EN 62031:2008+A1: 2013+A2:2015  
EN 62471:2008

**Description**

Cable section | Section du câble : 2 x 0.75mm<sup>2</sup>  
Cable type | Type de câble : H05V-K



Ø110 x 180mm

# Porcelain fixtures E27 with straight tube

Appliques porcelaine tube rigide

167514

167515



Black | Noir



White | Blanc

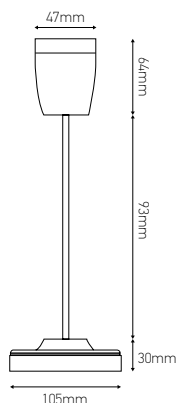

EN 60598-2-1:1989  
used in conjunction with  
EN 60598-1:2015  
EN 62031:2008+A1: 2013+A2:2015  
EN 62471:2008

**Description**

Cable section | Section du câble : 2 x 0.75mm<sup>2</sup>  
Cable type | Type de câble : H05V-K



Ø110 x 188mm

# Porcelain ceiling roses Ø105mm

Rosaces porcelaine



187518



Red | Rouge

187519



Grey | Gris

187520



White | Blanc

187521



Black | Noir

**Description**

Dimensions (Ø x H) : Ø105 x 30mm

**Application**

Provided with a kit for mounting (cable clamps, connector, nuts) & fixating. Max cable Ø : 7mm

Vendu avec kit de montage : barette de fixation, serre câble assorti, domino, écrous. Ø maximum de câble : 7mm

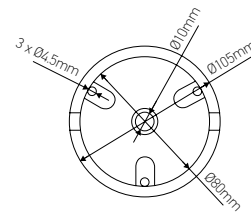

105 x 35 x 105mm

Cable | Câble 187535

Lampholder | Douille 187552

Bulb | Ampoule 716618

# Steel ceiling roses simple output Ø100mm

Pavillons acier sortie simple



187522

Bronze



187523

Copper | Cuivre



187524

Golden bronze | Bronze doré



187572

White | Blanc



187573

Black | Noir



187587

Mat bronze | Bronze mat

## Description

Dimensions (Ø x H) : Ø100 x 25mm

## Application

Provided with a kit for mounting (cable clamps, connector, nuts) & fixating. Max cable Ø : 7mm

Vendu avec kit de montage : barette de fixation, serre câble assorti, domino, écrous. Ø max du câble : 7mm

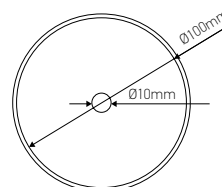

105 x 35 x 105mm

Cable | Câble 187531

Lampholder | Douille 187549

Bulb | Ampoule 716619

# Steel ceiling roses 3 outputs Ø100mm

Pavillons acier 3 sorties



187525



White | Blanc

187526



Black | Noir

187527



Chrome

187528



Copper | Cuivre

**Description**

Dimensions (Ø x H) : Ø100 x 25mm

**Application**

Provided with a kit for mounting (cable clamps, connector, nuts) & fixating. Max cable Ø : 7mm

Vendu avec kit de montage : barette de fixation, serre câble assorti, domino, écrous. Ø max du câble : 7mm

Cable | Câble 187580  
Lampholder | Douille 187552  
Bulb | Ampoule 716603

Cable | Câble 189600  
Lampholder | Douille 187550  
Bulb | Ampoule 716611

Cable | Câble 189601  
Lampholder | Douille 187549  
Bulb | Ampoule 716625

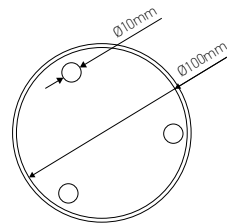

105 x 35 x 105mm

# Steel ceiling roses 5 outputs Ø300mm

Pavillons acier 5 sorties



187574



Copper | Cuivre

187575



Bronze

187576



Golden bronze | Bronze doré

187577



Black | Noir

187578



White | Blanc

## Description

Dimensions (Ø x H) : Ø300 x 25mm

## Application

Provided with a kit for mounting (cable clamps, connector, nuts) & fixating. Max cable Ø : 7mm

Vendu avec kit de montage : barette de fixation, serre câble assorti, domino, écrous. Ø max du câble : 7mm

Cable | Câble 187533  
Lampholder | Douille 187553  
Bulb | Ampoule 716629

Cable | Câble 187533  
Lampholder | Douille 187550  
Bulb | Ampoule 716629

Cable | Câble 187533  
Lampholder | Douille 187549  
Bulb | Ampoule 716629

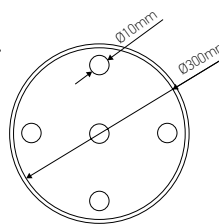

310 x 30 x 310mm

# Steel ceiling rose 6 outputs Ø100mm

Pavillon acier 6 sorties



187529



Black | Noir

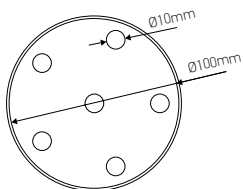

### Description

Dimensions (Ø x H) : Ø100 x 25mm

### Application

Provided with a kit for mounting (cable clamps, connector, nuts) & fixating. Max cable Ø : 7mm

Vendu avec kit de montage : barette de fixation, serre câble assorti, domino, écrous. Ø max du câble : 7mm



105 x 35 x 105mm

# Twisted textile cables 2 x 0.75mm<sup>2</sup>

Câbles textile torsadés



187530

Pink | Rose



187532

Orange



105 x 35 x 105mm

## Description

Length | Longueur : 200cm

Diameter | Diamètre : Ø6.5mm

Cable type | Type de câble : H05V-K

# Twisted natural textile cables 2 x 0.75mm<sup>2</sup>

Câbles chanvre torsadés



187598

Hemp | Chanvre



187599

Hemp | Chanvre



## Description

Length | Longueur : 200cm

Cable type | Type de câble : H05V-K

Diameter | Diamètre : Ø8mm

## Description

with E27 socket | avec douille E27

Length | Longueur : 200cm

Cable type | Type de câble : H03VV-F

Diameter | Diamètre : Ø25mm



105 x 35 x 105mm



250 x 200 x 130mm

# Twisted textile cables 2 x 0.75mm<sup>2</sup>

Câbles textile torsadés



189610

Gold | Or



189611

Brown | Marron



189612

Ivory | Ivoire

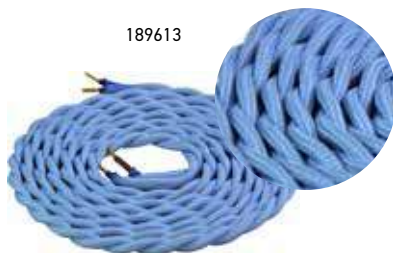

189613

Blue | Bleu



189614

Light grey | Gris clair



189615

Silver | Argent



189616

Grey | Gris



189617

Milky | Crème



189618

White & grey | Blanc & gris



189619

Beige & black | Beige & noir



189620

Dark gold | Or foncé

## Description

Length | Longueur : 200cm

Diameter | Diamètre : Ø6.5mm

Cable type | Type de câble : H05V-K



105 x 35 x 105mm



# Round textile cables 2 x 0.75mm<sup>2</sup>

Câbles textile ronds



187531

Orange



187533

Black & white | Noir & blanc



187534

White | Blanc



187535

Light gold | Or clair



187536

Black | Noir



187537

Brown | Marron



187538

Gold | Or



187539

Red | Rouge



187580

Green | Vert



187581

Dusty jade | Jade poudré



187582

Light blue | Bleu clair



189600

Pink | Rose



189601

Yellow | Jaune



189602

Blue | Bleu



189603

Black & white | Noir & blanc

## Description

Length | Longueur : 200cm

Diameter | Diamètre : Ø6mm

Cable type | Type de câble : H03VV-F

Double insulation | Double isolation

# Round textile cables 2 x 0.75mm<sup>2</sup>

Câbles textile ronds



189604



Mixed purple & white  
Mélange de violet & blanc

189605



Mixed pink & yellow  
Mélange de rose & jaune

189606



Mixed green & red  
Mélange de vert & rouge

189607



Mixed blue & black  
Mélange de bleu & noir

189608



Mixed yellow & black  
Mélange de jaune & noir

189609



Mixed red & purple  
Mélange de rouge & violet

189621



Mixed brown  
Mélange de marron

189626



Mixed grey & black  
Mélange de gris & noir

189627



Mixed grey  
Mélange de gris

189638

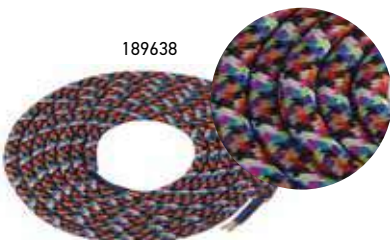

Mixed colour  
Mélange de couleur

189622



Mixed green & kaki  
Mélange de vert & kaki

189628



Mixed white & grey  
Mélange de blanc & gris

189630



Mixed silver & grey  
Mélange d'argent & gris

189634



Mixed green & white  
Mélange de vert & blanc

189639



Mixed yellow & white  
Mélange de jaune & blanc

## Description

Length | Longueur : 200cm

Diameter | Diamètre : Ø6mm

Cable type | Type de câble : H03VV-F

Double insulation | Double isolation

# Round textile cables 2 x 0.75mm<sup>2</sup>

Câbles textile ronds



189623

Light blue & white  
Bleu clair & blanc



189624

Rough grey  
Gris foncé



189625

Black & red  
Noir & rouge



189629

Fashion



189631

Natural | Ecu chiné



189632

Beige & kaki



189633

Pink & white  
Rose & blanc



189635

Beige gold  
Beige doré



189636

Natural hemp  
Chanvre naturel



189637

Pink, yellow & white  
Rose, jaune & blanc



189640

Dark blue & white  
Bleu foncé & blanc



189641

White & red  
Blanc & rouge



189642

Spiral blue & white  
Spirale bleu & blanc



189643

Spiral black & white  
Spirale noir & blanc



105 x 35 x 105mm

## Description

Length | Longueur : 200cm

Diameter | Diamètre : Ø6mm

Cable type | Type de câble : H03VV-F

Double insulation | Double isolation

# Porcelain lampholders E27

Douilles porcelaine

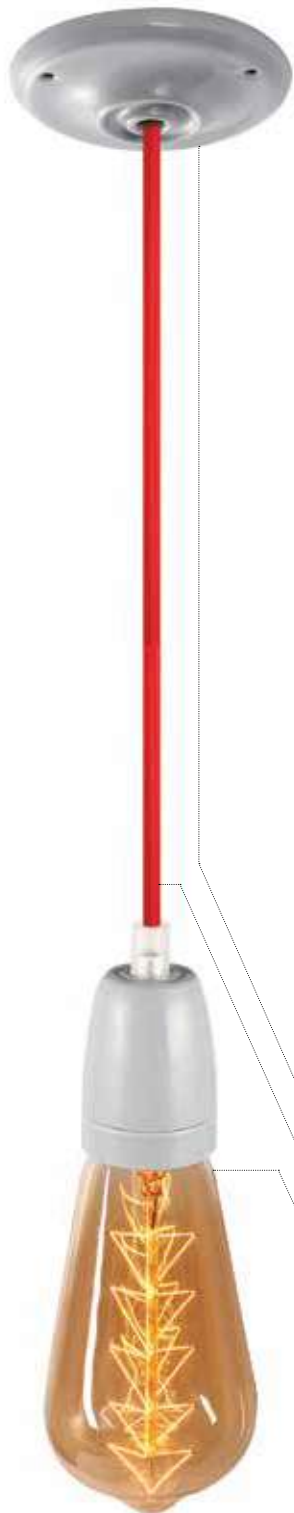

187540



Grey | Gris

187541



Red | Rouge

187554



Black | Noir

158063



White | Blanc

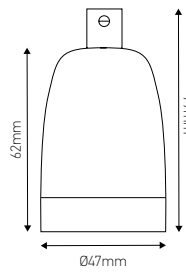

48 x 48 x 80mm

187542



White | Blanc

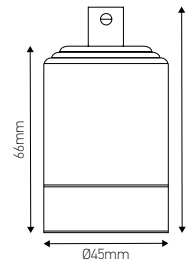

48 x 48 x 80mm

Ceiling rose | Rosace 187519

Cable | Câble 187539

Bulb | Ampoule 16000

# Steel threaded lampholders E27

Douilles acier filetées

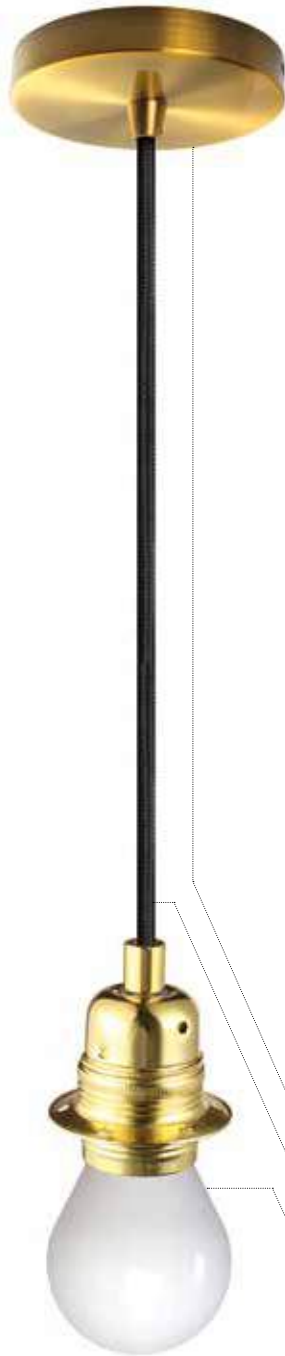

187545



Gold | Or  
with ring | avec bague

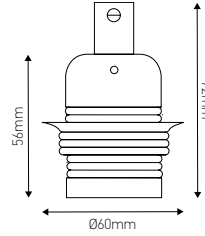

60 x 60 x 78mm

187546



Black | Noir

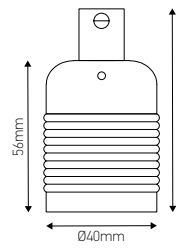

48 x 48 x 80mm

Ceiling rose | Pavillon 187524

Cable | Câble 187536

Bulb | Ampoule 719001

# Aluminium threaded lampholders E27 with ring

Douilles aluminium filetées avec bague



187543



Champagne

187544



Silver mat | Argent mat

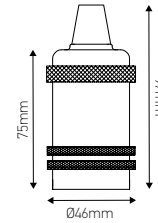

48 x 48 x 80mm

187550



Golden bronze | Bronze doré

187551



Bronze

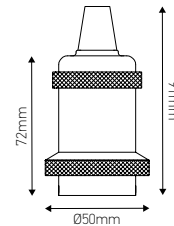

48 x 48 x 80mm

Ceiling rose | Pavillon 187523

Cable | Câble 189600

Cover plate | Disque 187586

Bulb | Ampoule 16004



# Threaded lampholders E27 with ring

Douilles filetées avec bague



187553



Copper | Cuivre

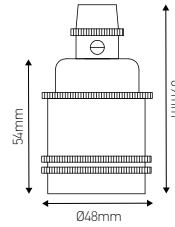

48 x 48 x 80mm

187571



Aluminium  
Metallic black | Noir métallisé

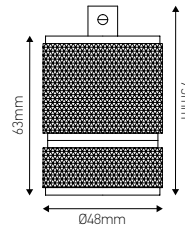

48 x 48 x 80mm

# Aluminium lampholders E27

Douilles aluminium

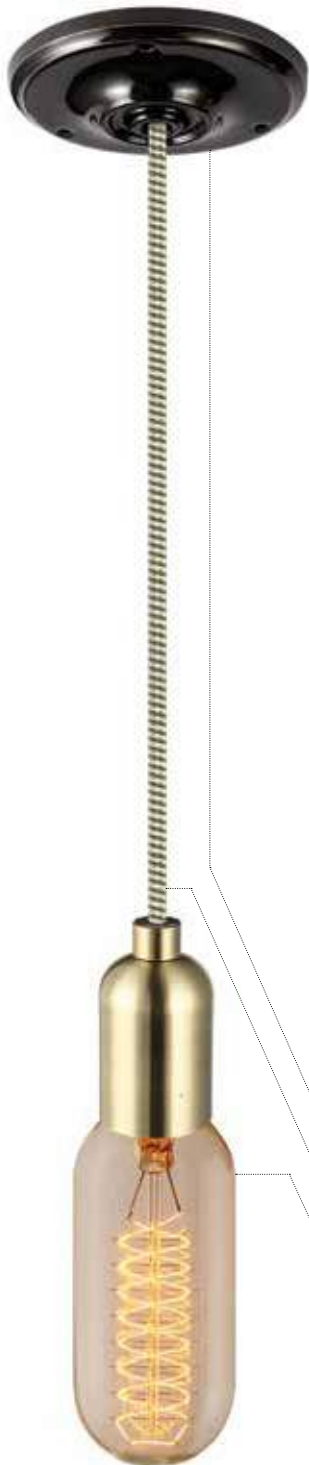

187547



Golden bronze  
Bronze doré

187548



Bronze

187549



Copper  
Cuivre

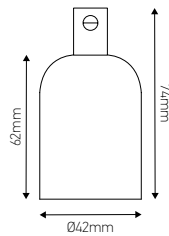

48 x 48 x 80mm

187552



Golden bronze  
Bronze doré

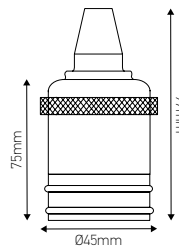

48 x 48 x 80mm

Ceiling rose | Rosace 187521

Cable | Câble 189628

Bulb | Ampoule 15992



# Aluminium lampholders E27

Douilles aluminium

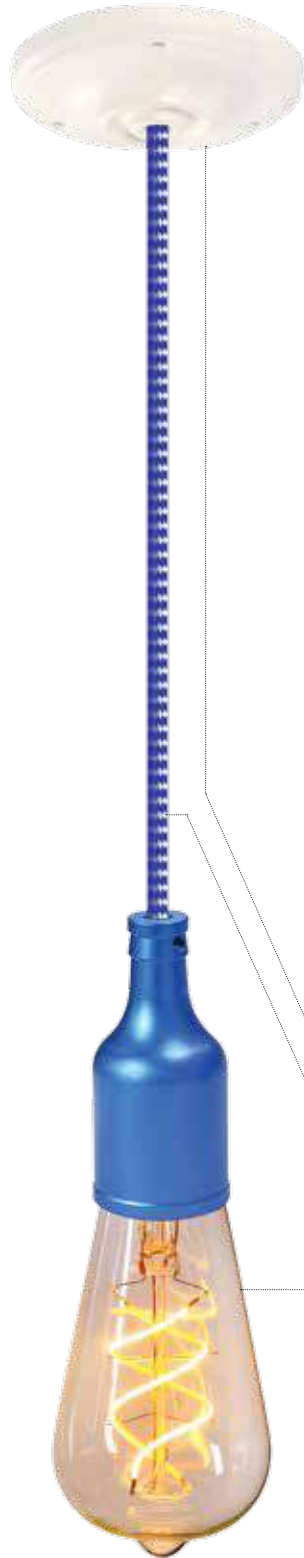

187564



Metallic black  
Noir métallisé

187565



Metallic fushia  
Fushia métallisé

187566



Metallic purple  
Violet métallisé

187567



Metallic blue  
Bleu métallisé

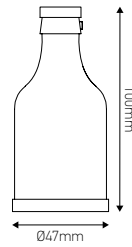

48 x 48 x 105mm

Ceiling rose | Rosace 187520

Cable | Câble 189640

Bulb | Ampoule 716622

# Aluminium lampholders E27

Douilles aluminium



187568



Metallic grey  
Gris anthracite

187569



Metallic antique  
Metal patiné

187570



Golden  
Doré

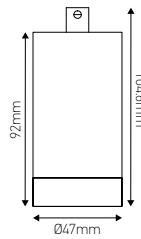

48 x 48 x 105mm

Ceiling rose | Pavillon 187573

Cable | Câble 187539

Bulb | Ampoule 160101

## Bakelite lampholder E27 with switch

Douille bakélite avec interrupteur

219331



Black | Noir  
Ø39 x 97mm



EN60238 2004  
A1 2008  
A2 2014

## Bakelite lampholder E27 with switch & ring

Douille bakélite avec bague et arrêt de câble

219341



Black | Noir  
Ø57 x 97mm



EN60238 2004  
A1 2008  
A2 2015

## Steel threaded lampholders E27 with rings

Douilles métalliques filetées avec bagues

220882

220883

220884

220885



Brass | Laiton  
Ø60 x 59mm



Galvanized | Zingué  
Ø60 x 59mm



Copper | Cuivre  
Ø60 x 59mm



Deep grey | Gris foncé  
Ø60 x 59mm



EN60238 2004  
A1 2008  
A2 2016

# Steel threaded lampholders E14 with rings

Douilles métalliques filetées avec bagues

210882



Brass | Laiton  
Ø42.5 x 66mm

210883



Galvanized | Zingué  
Ø42.5 x 66mm

210884



Copper | Cuivre  
Ø42.5 x 66mm

T 230°C



EN60238 2004  
A1 2008  
A2 2011



# Pair of steel cover plates

Paire de disques acier pour suspensions



187584



Black & copper  
Noir & cuivre

187586



Black & white  
Noir & blanc

### Application

To be used with a lampholder with ring | A utiliser avec une douille à bague

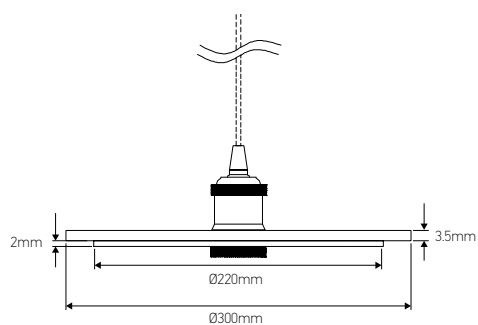

Dimensions :

Small cover plate | Petit disque : Ø220 x 2mm

Large cover plate | Grand disque : Ø300 x 3,5mm

Cable | Câble 187537

Lampholder | Douille 187553

Bulb | Ampoule 716624



305 x 50 x 305mm

# Metal shade

Abat-jour métal



187588



Black | Noir

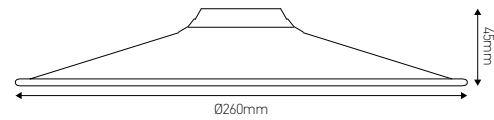

**Application**

To be used with a lampholder with ring | A utiliser avec une douille à bague

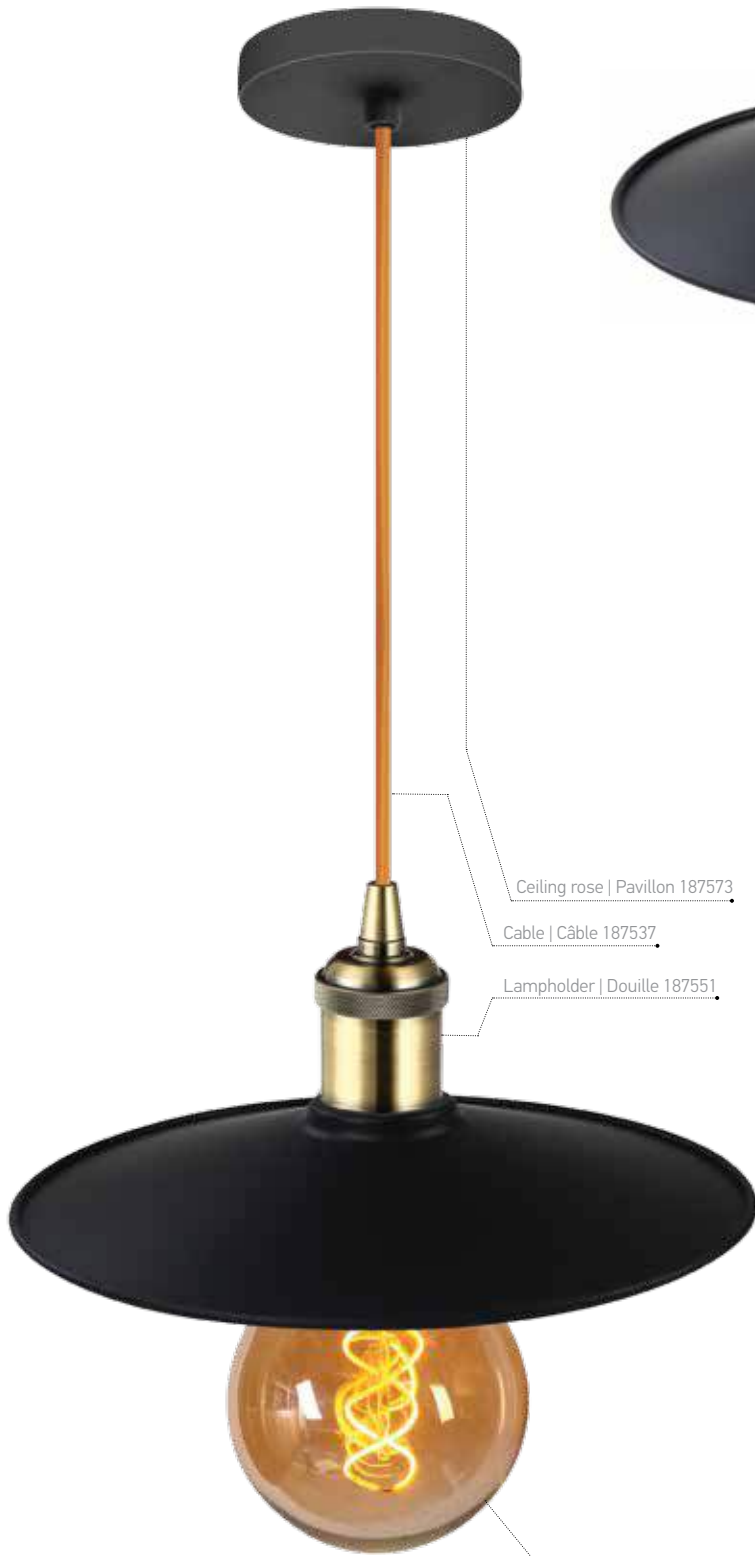

Ceiling rose | Pavillon 187573

Cable | Câble 187537

Lampholder | Douille 187551

Bulb | Ampoule 71661



265 x 55 x 265mm

# Metal shades

Abat-jours métal



187596



Black | Noir

187597



White | Blanc

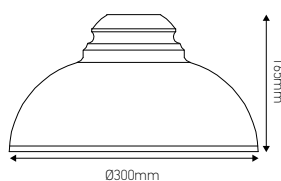

### Application

To be used with a lampholder with ring | A utiliser avec une douille à bague

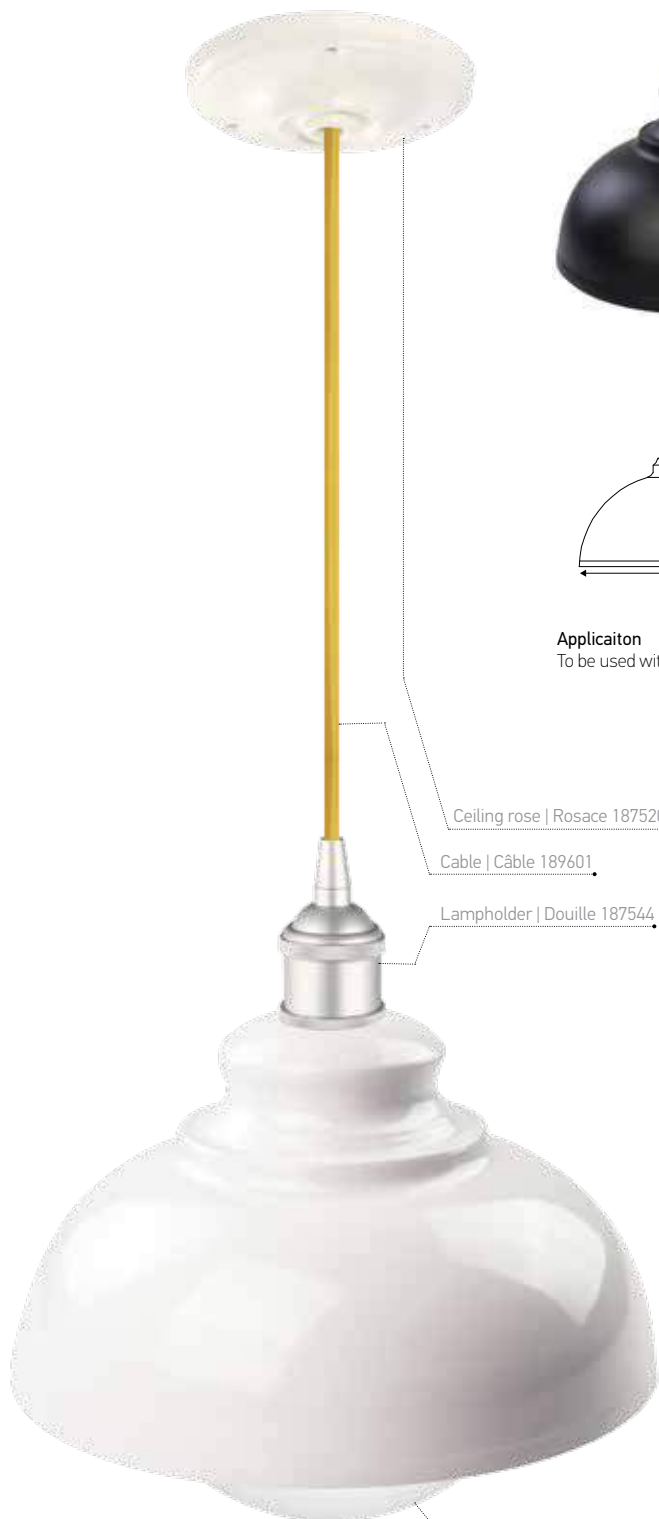

Ceiling rose | Rosace 187520

Cable | Câble 189601

Lampholder | Douille 187544

Bulb | Ampoule 719005



GIRARD  
SUDRON  
1884

Lamp shade  
165mm

305 x 305 x 170mm

# Metal shade

Abat-jour métal

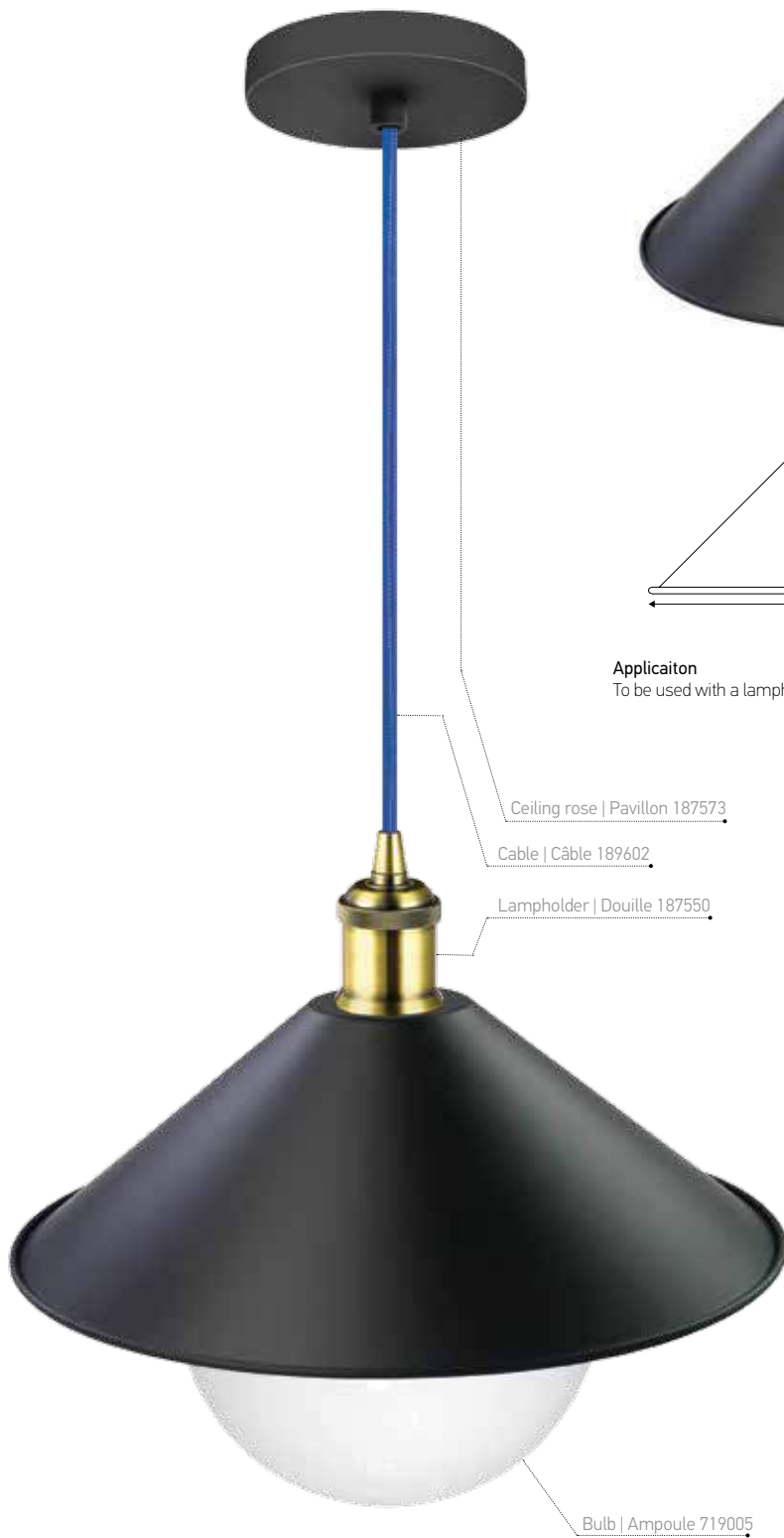

187589



Black | Noir

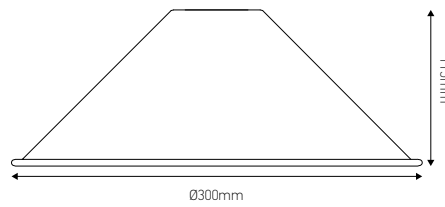

**Application**

To be used with a lampholder with ring | A utiliser avec une douille à bague

Ceiling rose | Pavillon 187573

Cable | Câble 189602

Lampholder | Douille 187550

Bulb | Ampoule 719005



305 x 305 x 120mm





Discover how to use our DIY products on Girard Sudron's Youtube (USE THE BRAND LOGO) channel  
Découvrez comment assembler les produits de la gamme DIY sur la chaîne Youtube de Girard Sudron".



# Suspensions



# Steel suspensions E27 (PVC cable L. 80cm)

Suspensions acier câble PVC

241602



Chrome plated | Chromé

241603



Brushed | Brossé

60W Max.

40

EN 60598-1 2008  
A1 2009

**Description**

Cable section | Section du câble : 3 x 0.75mm<sup>2</sup>

Cable type | Type de câble : FROR

Diameter | Diamètre : Ø100mm

Max weight of lampshade 4kg - hole Ø40mm | Poids max. de la abat-jour 4kg - trou Ø40mm

# Plastic suspensions E27 (textile cable L. 80cm)

Suspensions plastique câble textile

241622



White | Blanc

241629

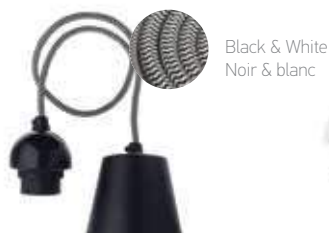

Black | Noir

241630



White | Blanc

60W Max.

50

**Description**

Cable section | Section du câble : 2 x 0.75mm<sup>2</sup>

Cable type | Type de câble : H03VVF

Diameter | Diamètre : Ø90mm

Material | Matériau : Polypropylene

Max weight of lampshade 1kg - hole Ø40mm | Poids max. de la abat-jour 1kg - trou Ø40mm

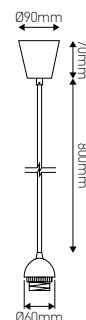

# Plastic suspensions lampholder with ring E27 (nylon cable L. 60cm)

Suspensions plastique avec bague câble nylon

241851

241853

241857



Black | Noir



White | Blanc



Gold | Or

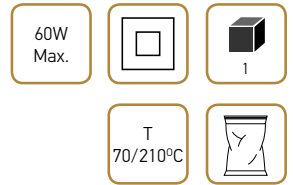

EN 60598-1 2015

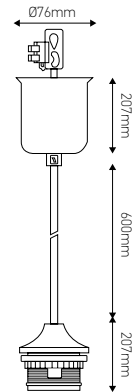

### Description

Cable section | Section du câble : 2 x 0.75mm<sup>2</sup>

Cable type | Type de câble : H03V2V2F-F

Diameter | Diamètre : Ø76mm

Material | Matériau : Polypropylene

Clevis hanger with clip & connector block 4mm - 2 blocks | Chape de suspension avec pince et barrette de connexion 4mm<sup>2</sup> - 2 plots

Ceiling cup with ring & locking screw | Pavillon avec anneau et vis de blocage

Nylon cable clamp | Serre-câble en nylon

Max weight of lampshade 1kg - hole Ø40mm | Poids max. de la abat-jour 1kg - trou Ø40mm

# Porcelain suspensions E27 (textile cable L. 100cm)

Suspensions porcelaine câble textile

241872

241875

241876



White | Blanc



White | Blanc



White | Blanc

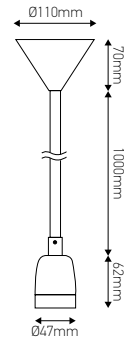

### Description

Cable section | Section du câble : 2 x 0.75mm<sup>2</sup>

Cable type | Type de câble : H03VVF

Diameter | Diamètre : Ø110mm

Material | Matériau

• Ceiling rose | Pavillon : Polypropylene | Polypropylène

• Socket | Douille : Porcelain | Porcelaine

# Porcelain suspensions E27 (textile cable L. 200cm)

Suspensions porcelaine câble textile

187875



Red | Rouge

White | Blanc

187876



Black | Noir

White | Blanc

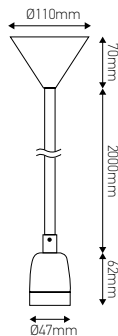

60W  
Max.



## Description

Cable section | Section du câble : 2 x 0.75mm<sup>2</sup>

Cable type | Type de câble : H03VVF

Diameter | Diamètre : Ø110mm

Material | Matériau

- Ceiling rose | Pavillon : Polypropylene | Polypropylène
- Socket | Douille : Porcelain | Porcelaine

# Plastic suspension with E14 ring (plastic cable L. 60cm)

Suspension plastique douille avec bague câble

241773



White | Blanc

60W  
Max.



## Description

Cable section | Section du câble : 2 x 0.75mm<sup>2</sup>

Cable type | Type de câble : H03VVF

Diameter | Diamètre : Ø75mm

Material | Matériau : Polypropylene

Max weight of lampshade 1kg - hole Ø28mm | Poids max. de la abat-jour 1kg - trou Ø28mm

# Truncated ceiling cup

Pavillon tronconique

241975

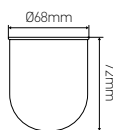

White | Blanc



## Description

Material | Matériau : Polypropylene | Polypropylène

# Cylindrical ceiling cup with locking screw

Pavillon cylindrique avec vis d'arrêt

241983

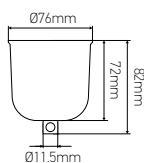

White | Blanc



## Description

Material | Matériau : Polypropylene | Polypropylène

# Conical ceiling cups with locking screw

Pavillons coniques avec vis d'arrêt

241991



Black | Noir

241993



White | Blanc

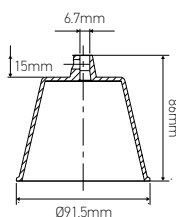

## Description

Material | Matériau : Polypropylene | Polypropylène





# Lampholders

Douilles



# Assembled lampholders E27

Douilles montées

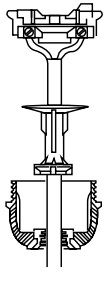

Thermoset Insulation | Isolant thermodurcissable  
Glow wire test at 850°C | Test au fil incandescent à 850°C  
Material | Matériau : Thermoplastic | Thermoplastique

Use isostop ref. 231627  
Utiliser un isostop réf. 231627

Delivered assembled with terminal upside down  
Livrées montées avec pastille à l'envers

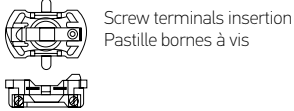

Screw terminals insertion  
Pastille bornes à vis

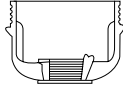

Metal nipple base 10 x 1 with retainer and stem locking screw  
Culot raccord métal 10 x 1 avec dispositif de retenue et vis d'arrêt



EN 60238

## Smooth outer shell Ø39mm

Chemise lisse

216391



Black | Noir

216393



Glazed white | Blanc vernissé

216397



Glazed gold | Or vernissé

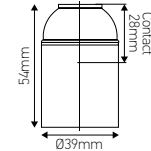

## Threaded outer shell Ø40mm

Chemise filetée

216501



Black | Noir

216503



Glazed white | Blanc vernissé

216507



Glazed gold | Or vernissé

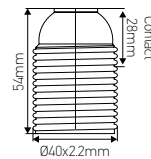

## Half-threaded outer shell with holder Ø40mm

Chemise semi-filetée avec portée

216571



Black | Noir

216573



Glazed white | Blanc vernissé

216577



Glazed gold | Or vernissé

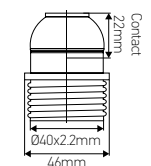

# Assembled lampholders E27

Douilles montées

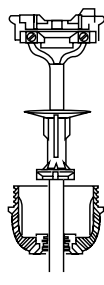

Thermoset Insulation | Isolant thermodurcissable  
 Glow wire test at 850°C | Test au fil incandescent à 850°C  
 Material | Matériau : Thermoplastic | Thermoplastique

Use isostop ref. 231627  
 Utiliser un isostop réf. 231627

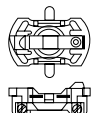

Screw terminals insertion  
 Pastille bornes à vis

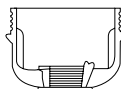

Delivered assembled with terminal upside down  
 Livrées montées avec pastille à l'envers

Metal nipple base 10 x 1 with retainer and stem locking screw  
 Culot raccord métal 10 x 1, avec dispositif de retenue et vis d'arrêt



EN60238 2004  
 A1 2008  
 A2 2055

## Smooth outer shell with side hole Ø39mm

Chemise lisse avec sortie latérale

216311



Black | Noir

216313



Glazed white | Blanc vernissé

216317



Glazed gold | Or vernissé

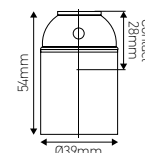

## Threaded outer shell with side hole Ø39mm

Chemise filetée avec sortie latérale

216321



Black | Noir

216323



Glazed white | Blanc vernissé

216327



Glazed gold | Or vernissé

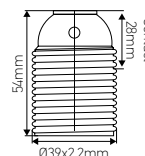

## Half-threaded outer shell with side hole & holder Ø46mm

Chemise semi-filetée avec sortie latérale et portée

216331



Black | Noir

216333



Glazed white | Blanc vernissé

216337



Glazed gold | Or vernissé

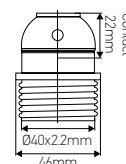

# Assembled lampholders E27

Douilles montées

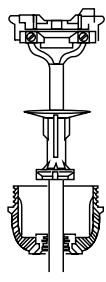

Thermoset Insulation | Isolant thermodurcissable  
Glow wire test at 850°C | Test au fil incandescent à 850°C  
Material | Matériau : Thermoplastic | Thermoplastique

Use isostop ref. 231627  
Utiliser un isostop réf. 231627

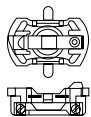

Screw terminals insertion  
Pastille bornes à vis

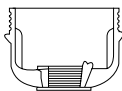

Delivered assembled with terminal upside down  
Livrées montées avec pastille à l'envers

Metal nipple base 10 x 1 with retainer, stem locking screw and earth terminal  
Culot raccord métal 10 x 1 avec dispositif de retenue, vis d'arrêt et borne de terre



EN60238 2004  
A1 2008  
A2 2046

## Smooth outer shell with earth Ø39mm

Chemise lisse avec la terre

216111



Black | Noir

216113



Glazed white | Blanc vernissé

216117



Glazed gold | Or vernissé

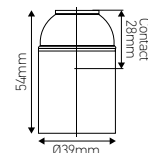

## Threaded outer shell with earth Ø40mm

Chemise filetée avec la terre

216121



Black | Noir

216123



Glazed white | Blanc vernissé

216127



Glazed gold | Or vernissé

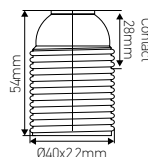

## Half-threaded outer shell with earth & holder Ø46mm

Chemise semi-filetée avec la terre et portée

216131



Black | Noir

216133



Glazed white | Blanc vernissé

216137



Glazed gold | Or vernissé

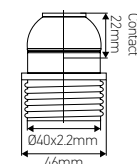



# Non-assembled lampholders E27

Douilles démontées

Thermoset Insulation | Isolant thermodurcissable  
 Glow wire test at 850°C | Test au fil incandescent à 850°C,  
 Material | Matériau : Thermoplastic | Thermoplastique

4A  
250V

T 190°C

**EN60238**

 Metal nipple base 10 x 1 with retainer, stem locking screw and earth terminal  
 Culot raccord métal 10 x 1 avec dispositif de retenue, vis d'arrêt et borne de terre

 Screw terminals insertion  
 Pastille bornes à vis

Use isostop ref. 231627  
 Utiliser un isostop réf. 231627

## Half-threaded outer shell with holder Ø40mm

Chemise semi-filetée avec portée

216071



Black | Noir

Shell | Chemise : 120043  
 Base | Culot : 120091  
 Terminal | Pastille : 120257

216073



Glazed white | Blanc vernissé

Shell | Chemise : 121307  
 Base | Culot : 121315  
 Terminal | Pastille : 120257

216265



Glazed silver | Vernissé argent

Shell | Chemise : 121309  
 Base | Culot : 121317  
 Terminal | Pastille : 120231



## Threaded outer shell Ø40mm

Chemise filetée

216091



Black | Noir

Shell | Chemise : 120045  
 Base | Culot : 120091  
 Terminal | Pastille : 120257



# Non-assembled lampholders E27

Douilles démontées

Thermoset Insulation | Isolant thermodurcissable  
Glow wire test at 850°C | Test au fil incandescent à 850°C



Screw terminals insertion  
Pastille bornes à vis



EN60238

## Threaded outer shell Ø40mm

Chemise lisse avec la terre

218063



Shell | Chemise : 121305  
Base | Culot : 121325  
Terminal | Pastille : 120231

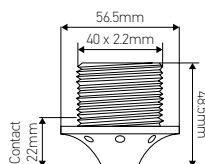

Glazed white | Blanc vernissé

Lampholders, base Ø56.5mm, smooth hole Ø10mm | Douilles, culot Ø56.5mm, trou lisse Ø10mm  
Threaded outer shell Ø40mm, height. 48mm | Chemise filetée Ø40mm, haut. 48mm

## With switch & holder

Avec interrupteur et portée

219321



Black | Noir

Lampholders with switch, metal nipple 10 x 1, locking screw | Douilles avec interrupteur, raccord métal 10 x 1, vis d'arrêt  
Threaded outer shell Ø40mm with holder | Chemise filetée Ø40mm avec portée  
Built-in switch | Interrupteur incorporé

# Non-assembled lampholder E27

Douille démontée

Thermoset Insulation | Isolant thermodurcissable  
Glow wire test at 650°C | Test au fil incandescent à 650°C

Use isostop ref. 231627

Utiliser un isostop réf. 231627.



Base nipple 10 x 1 and locking screw  
Culot raccord 10 x 1 et vis d'arrêt



EN60238

# Threaded outer shell with assembled insert holder Ø37.4mm

Chemise fileté avec portée pastille montée

218733



White | Blanc





# Assembled lampholders E14

Douilles montées

Thermoset Insulation | Isolant thermodurcissable  
Glow wire test at 850°C | Test au fil incandescent à 850°C,  
Material | Matériau : Thermoplastic | Thermoplastique

Use isostop ref. 231614  
Utiliser un isostop réf. 231614

Delivered assembled with terminal upside down  
Livrées montées avec pastille à l'envers



Screw terminals insertion  
Pastille bornes à vis



EN 60238

## Smooth outer shell, short base Ø27mm

Chemise lisse à culot court

213091



Black | Noir

213093



Glazed white | Blanc vernissé

213097



Glazed gold | Or vernissé

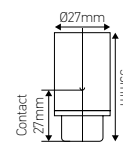

## Threaded outer shell, short base Ø28mm

Chemise filetée à culot court

213191



Black | Noir

213193



Glazed white | Blanc vernissé

213197



Glazed gold | Or vernissé

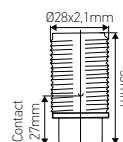

## Half-threaded outer shell with holder, short base Ø28mm

Chemise semi-filetée avec portée à culot court

213291



Black | Noir

213293



White | Blanc

213297



Gold | Or

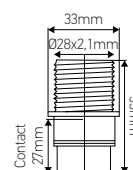

# Assembled lampholders E14

Douilles montées

Thermoset Insulation | Isolant thermodurcissable

Glow wire test at 850°C | Test au fil incandescent à 850°C.

Material | Matériau : Thermoplastic | Thermoplastique

The lampholders with a base height 16mm allow a class II fitting if they are assembled on a plastic support. For class I fitting: mounting on metal nipple connected to the earth.

Les douilles, culot hauteur 16mm permettent un équipement classe II si elles sont montées sur un support plastique. Equipement classe I montage sur raccord métallique relié à la terre.



Metal nipple base 10 x 1 with retainer and stem locking screw  
Culot raccord métal 10 x 1 avec dispositif de retenue et vis d'arrêt

Delivered assembled with terminal upside down  
Livrées montées avec pastille à l'envers



EN60238 2004  
A1 2008  
A2 2019

## Smooth outer shell Ø27mm

Chemise lisse

213511



Black | Noir

213513



White | Blanc

213517



Gold | Or

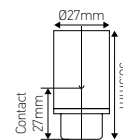

## Threaded outer shell Ø27mm

Chemise filetée

213521



Black | Noir

213523



White | Blanc

213527



Gold | Or

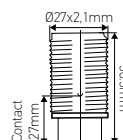

## Half-threaded outer shell with holder Ø28mm

Chemise semi-filetée avec portée

213531



Black | Noir

213533



White | Blanc

213537



Gold | Or

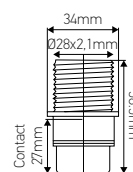

# Assembled lampholders E14

Douilles montées

Thermoset Insulation | Isolant thermodurcissable

Glow wire test at 850°C | Test au fil incandescent à 850°C.

Material | Matériau : Thermoplastic | Thermoplastique

The lampholders with a base height 16mm allow a class II fitting if they are assembled on a plastic support. For Class I fitting : mounting on metal nipple connected to the Earth.

Les douilles, culot hauteur 16mm permettent un équipement classe II si elles sont montées sur un support plastique.

Équipement classe I : montage sur raccord métallique relié à la terre.



Metal nipple base 10 x 1 with hole, with retainer and stem locking screw  
Culot raccord métal 10 x 1 percé avec dispositif de retenue et vis d'arrêt

Delivered assembled with terminal upside down  
Livrées montées avec pastille à l'envers

EN60238 2004  
A1 2008  
A2 2019

## Smooth outer shell with side hole Ø27mm

Chemise lisse à culot percé

213611



Black | Noir

213613



White | Blanc

213617



Gold | Or

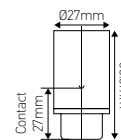

## Threaded outer shell with side hole Ø27mm

Chemise filetée à culot percé

213621



Black | Noir

213623



White | Blanc

213627



Gold | Or

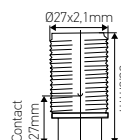

## Half-threaded outer shell with side hole and holder Ø28mm

Chemise semi-filetée à culot percé avec portée

213631



Black | Noir

213633



White | Blanc

213637



Gold | Or

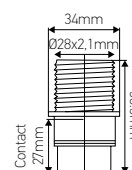

# Assembled lampholders E14

Douilles montées

Thermoset Insulation | Isolant thermodurcissable  
Glow wire test at 850°C | Test au fil incandescent à 850°C,  
Material | Matériau : Thermoplastic | Thermoplastique

Delivered assembled with terminal upside down  
Livrées montées avec pastille à l'envers

 Metal nipple base 10 x 1 with retainer, stem locking screw and earth terminal  
Culot raccord métal 10 x 1 avec dispositif de retenue, vis d'arrêt et borne de terre



EN60238 2004  
A1 2008  
A2 2019

## Smooth outer shell with earth Ø27mm

Chemise lisse avec la terre

213911



Black | Noir

213913



White | Blanc

213917



Gold | Or

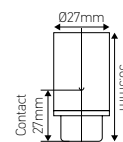

## Threaded outer shell with earth Ø27mm

Chemise filetée avec la terre

213921



Black | Noir

213923



White | Blanc

213927



Gold | Or

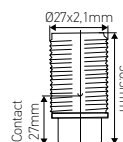

## Half-threaded outer shell with earth and holder Ø28mm

Chemise semi-filetée avec la terre et portée

213931



Black | Noir

213933



White | Blanc

213937



Gold | Or

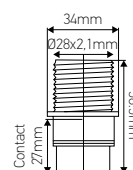

# Non-assembled lampholder E14

Douille démontée

Thermoset Insulation | Isolant thermodurcissable  
Glow wire test at 850°C | Test au fil incandescent à 850°C

Use isostop ref. 231627  
Utiliser un isostop réf. 231627.



Base nipple 10 x 1 and locking screw  
Culot raccord 10 x 1 et vis d'arrêt

Base height 16mm, cable passage Ø5,5mm  
Culot hauteur 16mm, passage de câble Ø5,5mm

Lamp holders, base height 16mm. Use with specific ISOSTOP ref. 231734 for base with side exit of cables for class II table lamps. Mounting class I chandeliers, cable outlet on the arm of chandeliers. Warning : the use of 16mm base with isostop for lateral side exit of cables does not permit the conformity of mounting on the level of distances in the air.

Douilles, culot hauteur 16mm. Utilisation avec isostop réf. 231734 spécifique pour culot avec passage de câble latéral pour lampes à poser classe II. Montage lustrerie classe I, sortie du câble sur bras de lustres.

Attention : l'utilisation du culot 16mm avec isostop pour passage de câble latéral ne permet pas la conformité du montage au niveau des distances dans l'air.

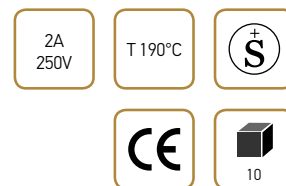

EN60238

# Smooth outer shell E14 Ø27mm

Chemise lisse

213351



Black | Noir

Shell | Chemise : 120041  
Base | Culot : 120083  
Terminal | Pastille : 120233

213353



White | Blanc

Shell | Chemise : 121277  
Base | Culot : 121293  
Terminal | Pastille : 120233

213357



Gold | Or

Shell | Chemise : 121593  
Base | Culot : 121579  
Terminal | Pastille : 120233

# Half-threaded outer shell with holder E14 Ø28mm

Chemise semi-filetée avec portée

213573



White | Blanc

Shell | Chemise : 121281  
Base | Culot : 121293  
Terminal | Pastille : 120233

# Non-assembled lampholder E14

Douille démontée

Thermoset Insulation | Isolant thermodurcissable  
Glow wire test at 850°C | Test au fil incandescent à 850°C



Threaded base 10 x 1  
Culot taraudé 10 x 1

Base height 16mm | Culot hauteur 16mm

Lampholder with base height 16mm, threaded 10 x 1 use exclusively with glue, locking nut or bracket lug.  
Douilles culot hauteur 16mm, taraudé 10 x 1 utilisation exclusive avec colle, contre-écrou ou patte équerre.



EN60238

# Smooth outer shell E14 Ø27mm

Chemise lisse

213663



White | Blanc

Shell | Chemise : 121277  
Base | Culot : 121291  
Terminal | Pastille : 120233

# Non-assembled lampholder E14

Douille démontée

Thermoplastic Insulation | Isolant thermoplastique  
Glow wire test at 650°C | Test au fil incandescent à 650°C

Use isostop ref. 231627  
Utiliser un isostop réf. 231627.

Stripping of cable : 7mm - conductor section | Dénudage du câble : 7mm - section conducteur  
0.5 to 1.5mm<sup>2</sup> - flexible or rigid cable | 0,5 à 1,5mm<sup>2</sup> - câble souple ou rigide

Automatic removable terminals, Snap-on base 10 x 1  
Bornes automatiques débrochables, culot clipsable 10 x 1

Lampholders, base height 21.5mm for class II light fitting. The internal volume of the base permits the insertion of an isostop with ref. 231614  
Douilles, culot haut. 21,5mm pour l'équipement des luminaires classe II. Le volume intérieur du culot permet l'insertion d'un isostop réf. 231614

Base height 21.5mm threaded 10 x 1 locking screw  
Culot haut. 21,5mm taraudé 10 x 1 vis d'arrêt

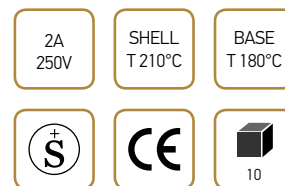

EN60238

# Smooth outer shell E14 Ø26mm

Chemise lisse

214513



White | Blanc

Shell | Chemise : 154893  
Base | Culot : 157581



# Half-threaded outer shell with holder E14 Ø28mm

Chemise semi-filetée avec portée

214591



Black | Noir

Shell | Chemise : 158021  
Base | Culot : 158045

214563



White | Blanc

Shell | Chemise : 157583  
Base | Culot : 158581



# Small rings for E27 lampholders

Petites bagues pour douilles

218401



Black | Noir

218403



Glazed white | Blanc vernissé

218407



Glazed gold | Or vernissé

T 230°C

10

## Description

Material | Matériau : Thermoplastic | Thermoplastique  
Dimensions (Ø x H) : Ø47 x 9mm

# Large rings for E27 lampholders

Grandes bagues pour douilles

218421



Black | Noir

218423



Glazed white | Blanc vernissé

218427



Glazed gold | Or vernissé

218433



White | Blanc

T 230°C

10

## Description

Material | Matériau : Thermoplastic | Thermoplastique  
Dimensions (Ø x H) : Ø57 x 12mm





# Small rings for E14 lampholders

Petites bagues pour douilles

214421



Black | Noir

214423



Glazed white | Blanc vernissé

214427



Glazed gold | Or vernissé

T 230°C



## Description

Material | Matériau : Thermoplastic | Thermoplastique  
Dimensions (Ø x H) : Ø35 x 7mm

# Large rings for E14 lampholders

Grandes bagues pour douilles

214451



Black | Noir

214453



Glazed white | Blanc vernissé

214457



Glazed gold | Or vernissé

T 230°C



## Description

Material | Matériau : Thermoplastic | Thermoplastique  
Dimensions (Ø x H) : Ø43 x 9.5mm

## Non-assembled lampholders E26 Ø39mm (smooth outer shell)

Douilles démontées chemise lisse

221461



Black | Noir

221463



White | Blanc

221467



Gold | Or



### Description

Dimensions (Ø x H) : Ø39 x 51.5mm

Material | Matériau : Thermoplastic | Thermoplastique

Non-assembled : 3 separate elements | Non-assemblé : 3 éléments séparés

Note : for reason of standardisation, these elements are not marketed separately | Note : pour des raisons de standardisation, ces éléments ne sont pas commercialisés séparément

## Non-assembled lampholders E26 Ø46mm

(Half-threaded outer shell with holder)

Douilles démontées chemise semi-filetée avec portée

221681



Black | Noir

221683



White | Blanc

221687



Gold | Or



### Description

Dimensions (Ø x H) : Ø46 x 51.5mm

Material | Matériau : Thermoplastic | Thermoplastique

Non-assembled : 3 separate elements | Non-assemblé : 3 éléments séparés

Note : for reason of standardisation, these elements are not marketed separately | Note : pour des raisons de standardisation, ces éléments ne sont pas commercialisés séparément

# Non-assembled lampholders E12 Ø27mm (Smooth outer shell)

Douilles démontées chemise lisse

215051



Black | Noir

215053



White | Blanc

215057



Gold | Or

T 150°C



## Description

Dimensions (Ø x H) : Ø27 x 49mm

Material | Matériau : Thermoplastic | Thermoplastique

Non-assembled : 3 separate elements | Non-assemblé : 3 éléments séparés

Note : for reason of standardisation, these elements are not marketed separately | Note : pour des raisons de standardisation, ces éléments ne sont pas commercialisés séparément

# Non-assembled lampholders E12 Ø34mm (Half-threaded outer shell)

Douilles démontées chemise semi-filetée

215271



Black | Noir

215273



White | Blanc

215275



Gold | Or

T 150°C



## Description

Dimensions (Ø x H) : Ø34 x 49mm

Material | Matériau : Thermoplastic | Thermoplastique

Non-assembled : 3 separate elements | Non-assemblé : 3 éléments séparés

Note : for reason of standardisation, these elements are not marketed separately | Note : pour des raisons de standardisation, ces éléments ne sont pas commercialisés séparément

# Assembled lampholders E27 Ø38mm (threaded outer shell with earth)

Douilles montées chemise filetée avec la terre

220879



Gold | Or

220889



Galvanized | Zingué

220888



Copper | Cuivre

220881



Charcoal grey | Gris charbon

4A  
250V

T 230°C



EN 60238

## Description

Material | Matériau : Steel | Acier

With locking device and earth terminal | Avec dispositif de blocage et borne de terre

Threaded metal nipple 10 x 1, stem locking screw | Raccord métal 10 x 1, vis d'arrêt

Screw terminal | Bornes à vis

Cables to be used | Câbles à utiliser : 0.5 to 2.5mm<sup>2</sup>

Dimensions (Ø x H) : Ø38 x 64mm

Delivered assembled with terminal upside down

Livrées montées avec pastille à l'envers

# Large rings for E27 lampholders

Grandes bagues pour douilles

220979



Gold | Or

220989



Galvanized | Zingué

220988



Copper | Cuivre

220981



Charcoal grey | Gris charbon

T 230°C



## Description

Material | Matériau : Steel | Acier

Dimensions (Ø x W) : Ø60 x 15.5mm

# Non-assembled lampholder E27 (Threaded outer shell)

Douille démontée chemise filetée

220936

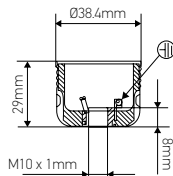
Brass-plated steel  
Acier laitonné

Shell | Chemise : 155779  
Base | Culot : 155781  
Terminal | Pastille : 158633

## Description

Synthetic resin insulation with metallic casing | Isolant résine de synthèse enveloppe métallique

Lampholder, metal nipple 10 x 1, locking screw and earth terminal | Douille raccord métal 10 x 1, vis d'arrêt et borne de mise à la terre



# Threaded lampholder E27 Ø38mm

Douille filetée

220969



White zinc-plated | Blanc zingué

## Description

Material | Matériau : White zinc-plated | Blanc zingué  
 Threaded metal nipple 10 x 1, stem locking screw | Raccord métal 10 x 1, vis d'arrêt  
 Screw terminal | Bornes à vis  
 Cables to be used | Câbles à utiliser : 0.5 to 2.5mm<sup>2</sup>  
 Dimensions (Ø x H) : Ø38 x 64mm

Delivered assembled with terminal upside down  
 Livrées montées avec pastille à l'envers

# Steel assembled lampholders E14 (threaded outer shell with earth)

Douilles montées en acier chemise filetée avec terre

210879

210889

210888



Gold | Or



Galvanized | Zingué



Copper | Cuivre



EN 60238

## Description

Material | Matériau : Steel | Acier  
 Threaded metal nipple 10 x 1, stem locking screw, earth terminal | Raccord métal 10 x 1, vis d'arrêt et borne de terre  
 Terminal : screw type for rigid or flexible cable 0.5 ÷ 25mm<sup>2</sup> | Terminal : vis pour câble rigide ou flexible 0,5 ÷ 25mm<sup>2</sup>  
 Dimensions (Ø x H) : Ø25 x 62mm

Delivered assembled with terminal upside down  
 Livrées montées avec pastille à l'envers

# Large rings for E14 lampholders

Grandes bagues pour douilles

210979

210989

210988



Gold | Or  
 Stainless steel | Acier inoxydable



Galvanized | Zingué  
 Steel | Acier



Copper | Cuivre  
 Copper-plated steel | Acier cuivré



## Description

Dimensions (Ø x H) : Ø42,5 x 11mm

# Transparent lampholders E14

Douilles transparentes

214514



Smooth outer shell | Chemise lisse

214534



Threaded outer shell | Chemise fileté

214584



Threaded outer shell with holder | Chemise fileté avec portée

2A  
250V

T 135°C



EN 60238

## Description

Material | Matériau : Thermoplastic | Thermoplastique

Spring type terminals for rigid or flexible cables from 0.5 ÷ 1.5mm<sup>2</sup> | Bornes à ressort pour câbles rigides ou flexibles à partir de 0.5 ÷ 1.5mm<sup>2</sup>

Connection : through holes for self-threading screws 3mm or with snap-on domes | Raccordement : trous traversants pour vis auto-enfilage 3mm ou avec dômes à encliquetage

With threaded fitting M10 x 1 with retainer and stem locking screw | Avec raccord fileté M10 x 1, avec dispositif de retenue et vis d'arrêt

Dimensions (Ø x H) : Ø26.5 x 58mm

# Transparent small ring for E14 lampholder

Petite bague transparente pour douille

214444



EN 60238

## Description

Material | Matériau : Thermoplastic | Thermoplastique

Dimensions (Ø x H) : Ø43 x 9.5mm

# Smart touch E27 lampholder with LED dimmer

Douille E27 avec variateur LED sensitive

158856



Black | Noir

220-240V

CE



## Description

Power | Puissance : 4 - 25 W

Finish | Finition : Plastic | Plastique

Cable section | Section du câble : 0.5 - 2.5mm<sup>2</sup>

Dimensions (Ø x H) : Ø38 x 88mm

For flat cables H03VVH2-F 2 x 0.75mm<sup>2</sup> & round cables H03VV-F 2 x 0.75mm<sup>2</sup>

Pour câbles plats H03VVH2-F 2 x 0.75mm<sup>2</sup> & câbles ronds H03VV-F 2 x 0.75mm<sup>2</sup>

# Brass bayonet cap lampholders B22 (French thread with ring)

Douilles à baïonnette en laiton pas français avec bague

210206



Gold | Or

Female thread 10 x 1  
Raccord femelle 10 x 1

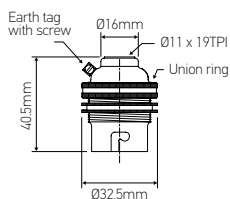

210215



Gold | Or

With side hole  
Avec trou latéral

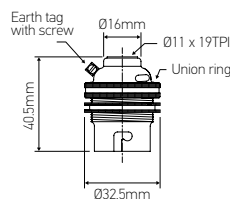

EN 61184

## Description

Female thread 10 x 1. Locking screw and earth terminal | Raccord femelle 10 x 1. Vis d'arrêt et borne de terre

# Brass bayonet cap lampholders B22 (International thread)

Douilles à baïonnette en laiton pas international

210221



Gold | Or

210226



Gold | Or

With ring  
Avec bague

210229



Gold | Or

With side hole and double ring  
Avec trou latéral et double bague

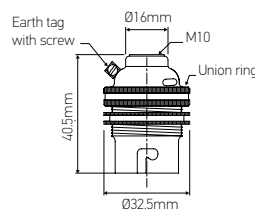
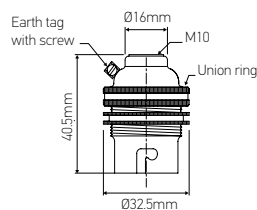
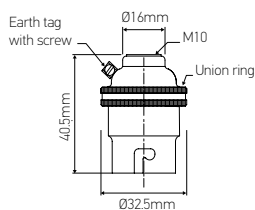

EN 61184

## Description

Female thread 10 x 1. Locking screw and earth terminal | Raccord femelle 10 x 1. Vis d'arrêt et borne de terre

# Chrome-plated brass bayonet cap lampholder B22

(French thread with ring)

Douille à baïonnette en laiton chromé pas français avec bague

142693



Chrome-plated brass  
Laiton chromé

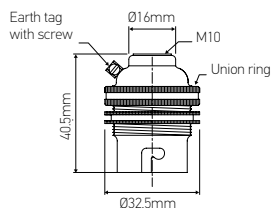

EN 61184

## Description

Female thread 10 x 1. Locking screw and earth terminal | Raccord femelle 10 x 1. Vis d'arrêt et borne de terre

# Brass bayonet cap lampholder B22 (BC) with hook

Douille à baïonnette en laiton avec patère

210247



Gold | Or

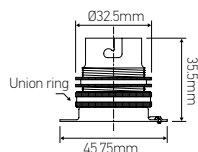

EN 61184

## Description

Batten Ø45mm with earth terminal | Patère Ø45mm avec borne de terre

# Brass bayonet cap lampholder B22 (BC) with pushbar switch

(International thread with ring)

Douille à baïonnette en laiton pas international avec interrupteur poussoir et bague

210258



Brass | Laiton

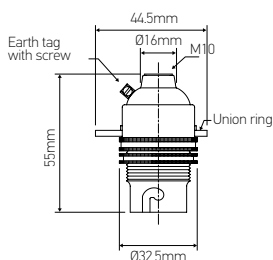

EN 61184

## Description

Female thread 10 x 1. Locking screw and earth terminal | Raccord femelle 10 x 1. Vis d'arrêt et borne de terre



# Brass bayonet cap lampholder B15 (SBC) with shade ring (International thread with double ring)

Douille à baïonnette en laiton pas international avec double bague

210298



Brass | Laiton

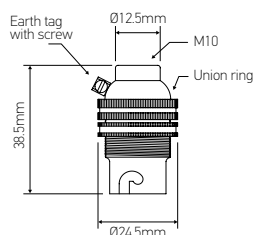

EN 61184

## Description

Female thread 10 x 1. Locking screw and earth terminal | Raccord femelle 10 x 1. Vis d'arrêt et borne de terre

# Plier for B15 & B22 lampholders

Pince de serrage pour double bague

210385



Grey | Gris



## Description

Material | Matériau : Aluminium

# Brass-plated steel lampholders E14/E27 (with threaded outer shell)

Douilles en acier laitonné à chemise filetée

210587

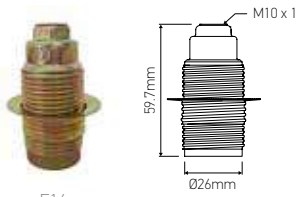

E14  
Brass-plated steel  
Acier laitonné

210690

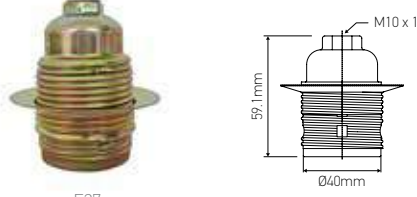

E27  
Brass-plated steel  
Acier laitonné



## Description

Material | Matériau : Brass-plated steel | Acier plaqué laiton

Female thread 10 x 1. Locking screw, porcelain contact insert and flange | Raccord femelle 10 x 1. Vis d'arrêt et, pastille et collerette interne en porcelaine

To be used with ring | A utiliser avec une bague : refs. 210589 (E14) & 210692 (E27)

# Brass-plated steel rings for lampholders E14/E27

Bagues en acier laitonné

210589



for E14 | pour E14  
Brass-plated steel  
Acier laitonné

210692



for E27 | pour E27  
Brass-plated steel  
Acier laitonné



# Porcelain lampholder E14 (with screwed adaptor)

Douille en porcelaine E14 avec étrier vissé

221014



White | Blanc

2A  
250V

T 210°C



1000

## Description

Nickel-plated brass contacts | Contacts laiton nickelé

With 10 x 1 threaded adaptor, locking screw & earth terminal | Raccord métal 10 x 1, vis d'arrêt et borne de mise à la terre

# Porcelain lampholder E27 (conical)

Douille en porcelaine conique

221123



White | Blanc

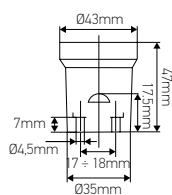

4A  
250V

T 210°C

1000

## Description

Nickel-plated brass contacts | Contacts laiton nickelé

Rear fixing by screws | Fixation arrière par vis

# Porcelain lampholder E27 (with mounting bracket & earth terminal)

Douille en porcelaine étrier de fixation avec borne de mise à la terre

221246



White | Blanc

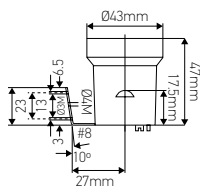

## Description

Nickel-plated brass contacts | Contacts laiton nickelé

With mounting bracket with earth terminal | Étrier de fixation avec borne de mise à la terre

# Porcelain lampholder E27 (with screwed adaptor)

Douille en porcelaine E27 avec étrier vissé

221342



White | Blanc

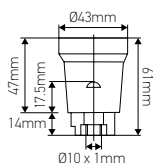

## Description

Nickel-plated brass contacts | Contacts laiton nickelé

With 10 x 1 threaded adaptor, locking screw & earth terminal | Avec adaptateur fileté 10 x 1, vis de blocage et borne de terre

# Porcelain lampholder E40 (with bayonet bracket)

Douille en porcelaine E40 avec étrier à baïonnette

221859



White | Blanc

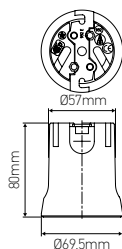

16A  
750V

T 210°C

100

## Description

Nickel-plated brass ferrule, terminal screws with anti-vibration, rotation spring | Virole feuille laiton nickelé, bornes à vis avec frein de filet anti-vibration  
Mounting distance : 57mm | Entraxe de fixation : 57mm

# Porcelain lampholder E27 (with snap-on domes)

Douille en porcelaine E27 avec étrier à baïonnette

153373



White | Blanc

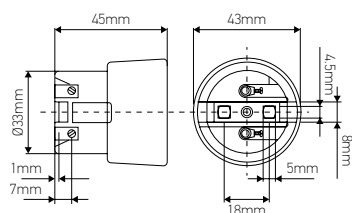

4A  
750V

T 180°C

## Description

Screw type terminals for rigid or flexible Cables 0.5 ÷ 2.5mm<sup>2</sup> | Bornes à vis pour câble rigide ou flexible 0.5 ÷ 2.5mm<sup>2</sup>  
Screwed shell | Coque vissée : Zinc-plated steel | Acier zingué

# Lampholder R7S for 117.6mm lamp

Douille avec étrier

260035

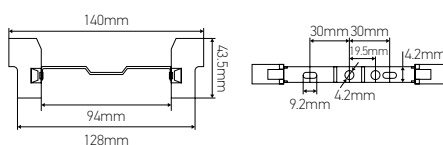
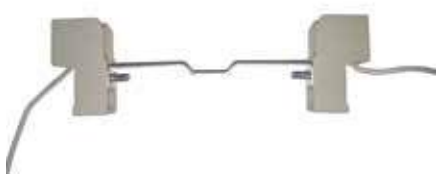

CE

250

## Description

Treated steel bracket | Étrier acier traité  
Dimensions : 140 x 14 x 43mm, mounting distance 60mm | 140 x 14 x 43mm, entraxe de fixation 60mm  
Silicone cables, brass fittings | Câbles silicone, embouts laiton  
Double crimping | Double sertissage

# Lampholder R7S

Douille avec étrier

260049



## Description

Dimensions : 139 x 14 x 43mm

Finish | Finition : Steel | Acier

# Lampholder R7S

Douille avec étrier

260056

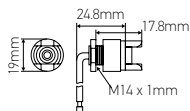

## Description

Material | Matériau : Ceramic nickel-plated brass | Laiton nickelé-céramique

Finish | Finition : Steel | Acier

Silicon Cable L. 250mm T 180°C | Câble silicone L. 250mm T 180°C

# Lampholder R7S for 78mm lamp

Douille avec étrier

260067

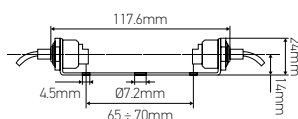

## Description

Treated steel bracket | Étrier en acier traité

Dimensions : 112 x 20 x 26mm, mounting distance 70mm | 112 x 20 x 26mm, entraxe de fixation 70mm

Central hole | Trou central : Ø11mm

# Lampholders for "linolite" lamps S15 / S19

Douilles pour lampes « linolites »

210731

210853



EN 60598



S15  
Cream | Crème



S19  
Cream | Crème

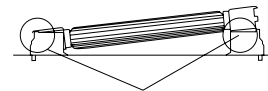

**Description**

Material | Matériau : Lexan 740

Dimensions (Ø x H) : Ø30 x 43mm

To make class II light fittings | Pour équiper les luminaires classe II

# Lampholders for "linolite" lamps S14d / S14s

Douilles pour lampes « linolites »

210596

210597



IEC 60838-2-1

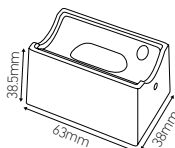

S14d  
White plastic  
Plastique blanc

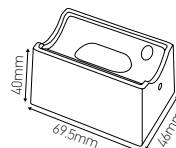

S14d  
Chrome-plated metal  
Métal chromé

210598

210599

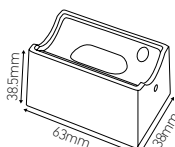

S14s  
White plastic  
Plastique blanc

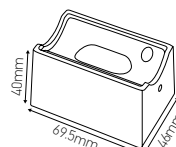

S14s  
Chrome-plated metal  
Métal chromé

# Lampholder R7S for 117.6mm lamp

Douille avec étrier

260078



## Description

Treated steel bracket | Étrier en acier traité

Dimensions : 150 x 24 x 26mm, mounting distance 70mm | 150 x 24 x 26mm, entraxe de fixation 70mm

Central hole | Trou central : Ø11mm





# G4 lampholder for low voltage halogen

Douille G4 pour sources halogènes TBT

262015

T 180°C

6A  
12V

EN 60838-1

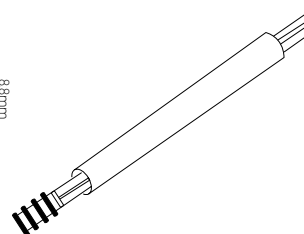
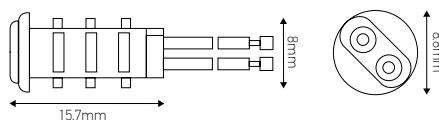

## Description

Tinned nickel-plated bronze contacts | Contacts bronze nickelé  
Silicone cable | Câble silicone : 1 x 0.75mm<sup>2</sup>  
Length 150mm for tube | Longueur 150mm pour tube  
Interior diam. 7.8 ± 0.10mm | Diamètre int. 7.8 ± 0.10mm  
Dimensions : Ø17 x 10.2mm  
Diameter | Diamètre : Ø8.8mm

# G4 lampholder for low voltage halogen

Douille G4 pour sources halogènes TBT

262024

LCP  
T 240°C

6A  
24V



White | Blanc

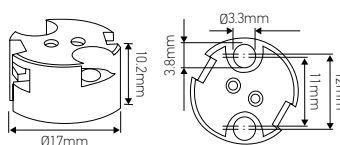

## Description

Bronze contact | Contacts bronze  
Spring terminals | Connexions automatiques  
Stripping of cable: 5mm | Dénudage du câble : 5mm  
Mounting distance 11mm, hole Ø3.3mm | Entraxe de fixation 11mm, trou Ø3.3mm  
For pins | Pour broches : G.4 - GZ.4  
Dimensions : Ø17 x 10.2mm

# G4 lampholder for low voltage halogen

Douille G4 pour sources halogènes TBT

262036

10A  
24 V

T 350°C



White | Blanc

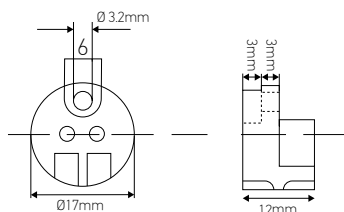

## Description

Nickel-plated brass contact with connection screw & locking screw pin  $\varnothing 17\text{mm}$  | Contacts laiton nickelé avec vis de connexion et vis de blocage  $\varnothing 17\text{mm}$

Pin-type lampholder | Douille pour broches

G.4 - GX.4 - G5.3 - GX5.3 G6.35 - GX6.35 - GY6.35 - GZ6.35

Diameter | Diamètre :  $\varnothing 17\text{mm}$

# G4 lampholder for low voltage halogen

Douille G4 pour sources halogènes TBT

262041

8A  
24 V

T 240°C

100/1000

EN 60838-1  
UL 496  
CSA C22



White | Blanc

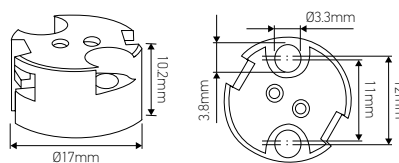

## Description

Fixing holes | Trous de fixation :  $\varnothing 3.3\text{mm}$

Dimensions :  $\varnothing 17 \times 10.2\text{mm}$

Steatite body | Corps en steatite

Push in terminals | Bornes à poussoir

Nickel bronze contacts | Contacts en bronze nickelé

# G5 lampholder for low voltage halogen

Douille G5 pour sources halogènes TBT

262046



White | Blanc

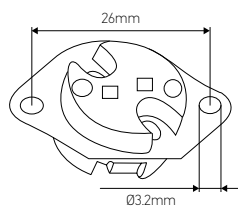

10A  
24 V

T 300°C



## Description

Nickel-plated brass contacts 17 x 11mm | Contacts laiton nickelé 17 x 11mm

Silicon cables | Câbles silicone 1 x 0.75mm<sup>2</sup> - T 180°C - 1.50m

Diameter | Diamètre : Ø26mm

High temperature protection | Protection haute température

# Lampholder for low voltage halogen

Douille pour sources halogènes TBT

262048



White | Blanc

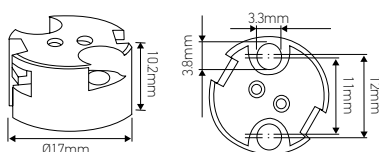

10A  
24 V

T 300°C



## Description

Nickel-plated brass contacts 17 x 11mm | Contacts laiton nickelé 17 x 11mm

Mounting distance 11mm, holes Ø3.3mm | Entraxe de fixation 11mm, trous Ø3,3mm

Teflon cable | Câble téflon : 1 x 0.75mm<sup>2</sup> - T 200°C - L.1m

High temperature protection | Protection haute température

# Low voltage halogen and LED G9 Lampholder

Douille G9 pour sources halogène basse tension et LED

269146



White | Blanc

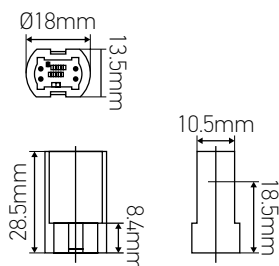

2A  
250V

T 280°C

## Description

Material | Matériau : Steatite | Stéatite  
Diameter | Diamètre : Ø18mm  
Dimensions : 13.5 x 10.5 x 28.5mm

# GU10 lampholder

Douille GU10

262171



White | Blanc

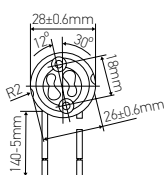

## Description

Material | Matériau : Porcelain | Porcelaine  
For low tension halogen lamps | Pour lampes halogènes basse tension  
Vertical cable outlet | Sortie de câble verticale  
PTFE 0.75 cable | Câble PTFE 0,75  
L. 150mm - crimped ends | extrémités sertis  
Diameter | Diamètre : Ø28mm

262185



Black | Noir

## Description

PET 180°C  
Snap-on threaded dome 10 x 1 | Capuchon fileté 10 x 1  
For class II mounting | Pour montage classe II  
Diameter | Diamètre : Ø30mm

2A  
250V

# GU10 lampholder with holder

Douille GU10 avec support

262180



Black & white | Noir & blanc

## Description

Silicone cable holder | Support câble en silicone : 15cm  
Non-compatible with recessed fitting in stamped metal | Non compatible avec les enjoliveurs en métal embouti



# Extension clip

Rehausse clipsable

269324

EN 60838-1



White | Blanc

**Description**

PPS thread M10 x 1 | Rehausse PPS filetage M10 x 1  
 For low tension halogen lamps | Pour lampes halogènes basse tension  
 Height | Hauteur : 21.1mm

# PPS Sleeve for female low voltage lampholder 10 x 1

Manchon PPS pour douille TBT femelle 10 x 1

262049

T 220°C

100/1000



White | Blanc

**Description**

Dimensions : Ø17 x 12.1mm

# Self-tapping screw

Vis auto-taraudeuse

262100

100/1000

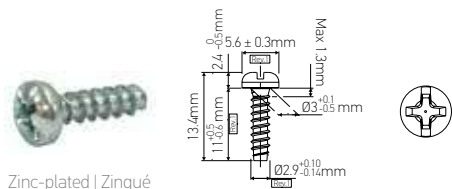

Zinc-plated | Zingué

**Description**

Dimensions : Ø3 x 13.4mm

# Screw for lampholder

Vis pour douille

157163



Zinc-plated | Zingué

**Description**

Dimensions : Ø3 x 11mm



# Cables & cords

Câbles & cordons



# Flat textile cables 2 x 0.5mm<sup>2</sup>

Câbles textile méplat

237571



Black | Noir

237572



Brown | Marron

237577



Gold | Or



### Description

Length | Longueur : 25m  
Cable type | Type de câble : SVOTM  
Braided conductor wire, PVC sleeve | Fil conducteur tressé, manchon PVC

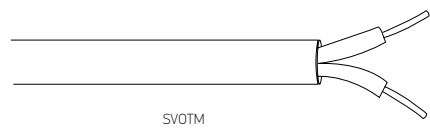

# Flat textile cable 2 x 0.75mm<sup>2</sup>

Câble textile méplat

237711



Black | Noir



### Description

Length | Longueur : 100m  
Cable type | Type de câble : H05VVH-2F  
Double insulation | Double isolation

# Round textile cables 2 x 0.75mm<sup>2</sup>

Câbles textile rond

237881



Black | Noir

237886



Red | Rouge

237893



White | Blanc

237894



Grey | Gris

237895



Black & white  
Noir & blanc



### Description

Length | Longueur : 25m  
Cable type | Type de câble : H03VV-F  
Double insulation | Double isolation



# Flat textile cables 2 x 0.34mm<sup>2</sup>

Câbles textile méplat

237647



Gold | Or  
Length | Longueur : 100m

237648



Gold | Or  
Length | Longueur : 25m



H03VVH-2F



## Description

Dimensions (Ø x W) : Ø4.15 x 2.95mm

Cable type | Type de câble : H03VVH-2F

Braided conductor wire, PVC sleeve | Fil conducteur tressé, manchon PVC

Double insulation | Double isolation



# Flat PVC cables 2 x 0.4mm<sup>2</sup>

Câbles PVC méplat



T 85°C

1

**Description**

Dimensions (Ø x W) : Ø4.35 x 2.15mm  
 Length | Longueur : 100m  
 Cable type | Type de câble : H03VH-H2



# Flat PVC cables 2 x 0.5mm<sup>2</sup>

Câbles PVC méplat



T 85°C

1

**Description**

Dimensions (Ø x W) : Ø5.1 x 2.15mm  
 Length | Longueur : 25m  
 Cable type | Type de câble : H03VH-H

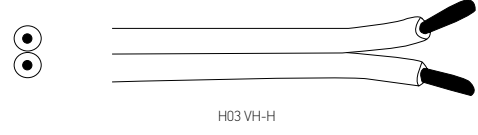

# Round PVC cables 1 x 0.75mm<sup>2</sup>

Câbles PVC rond



T 85°C

1

**Description**

Diameter | Diamètre : Ø2mm  
 Length | Longueur : 100m  
 Cable type | Type de câble : H05VK  
 Flexible conductors | Conducteurs souples



# Rigid PVC round cables 1 x 0.5mm<sup>2</sup>

Câbles PVC rigide rond



236400

Grey | Gris

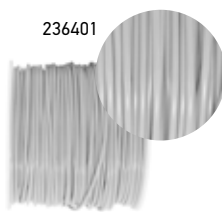

236401

White | Blanc



## Description

Diameter | Diamètre : Ø2.8mm  
 Length | Longueur : 100m  
 Cable type | Type de câble : G 105°C 8/10 DET  
 Double PVC protection | Double protection PVC  
 Double insulation | Double isolation



G 105°C 8/10 DET

# Rigid PVC round cables 1 x 0.75mm<sup>2</sup>

Câbles PVC rigide rond



236463

White | Blanc



236474

Grey | Gris



## Description

Diameter | Diamètre : Ø2.2mm  
 Length | Longueur : 100m  
 Cable type | Type de câble : H05V2-U  
 PVC round sleeve, rigid wire | Manchon rond en PVC, fil rigide



H05V2-U

# Twisted textile cables 2 x 0.5mm<sup>2</sup>

Câbles textile torsadé

237043



White | Blanc

237051



Black | Noir

237062



Brown | Marron

237077



Gold | Or



237079



Antique gold | Or antique

237094

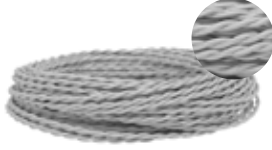

Grey | Gris



**Description**

Length | Longueur : 25m

Cable type | Type de câble : SVT

Braided conductor wire, PVC sleeve | Fil conducteur tressé, manchon PVC

# Twisted textile cables 2 x 0.5mm<sup>2</sup>

Câbles textile torsadé

237943



White | Blanc

237941

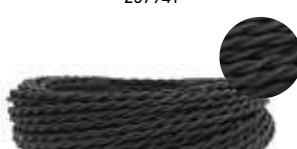

Black | Noir

237942



Brown | Marron



237949



Antique gold | Or antique

237944



Grey | Gris

237947



Gold | Or

**Description**

Diameter | Diamètre : Ø5mm

Length | Longueur : 50m

Cable type | Type de câble : H05V-K

# Twisted textile cables 2 x 0.75mm<sup>2</sup>

Câbles textile torsadé

237133

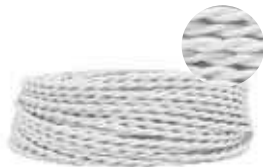

White | Blanc

237141



Black | Noir

237142



Brown | Marron

237147



Gold | Or



237149

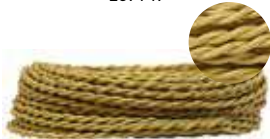

Antique gold | Or antique

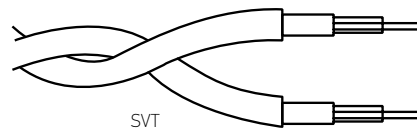

## Description

Length | Longueur : 25m

Cable type | Type de câble : SVT

Braided conductor wire, PVC sleeve | Fil conducteur tressé, manchon PVC

# Twisted textile cable 2 x 0.75mm<sup>2</sup>

Câble textile torsadé

237487



Gold | Or



## Description

Length | Longueur : 25m

Cable type | Type de câble : SVT

Braided conductor wire, PVC sleeve | Fil conducteur tressé, manchon PVC

Double insulation | Double isolation

# Twisted textile cable 3 x 0.5mm<sup>2</sup>

Câble textile torsadé

237331



Black | Noir

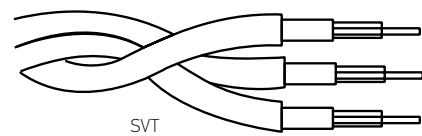

### Description

Length | Longueur : 25m

Cable type | Type de câble : SVT

Braided conductor wire, PVC sleeve | Fil conducteur tressé, manchon PVC

# Twisted textile cable 3 x 0.75mm<sup>2</sup>

Câble textile torsadé

237457



Gold | Or

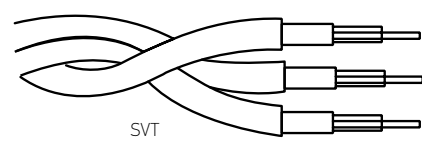

### Description

Length | Longueur : 25m

Cable type | Type de câble : SVT

Braided conductor wire, PVC sleeve | Fil conducteur tressé, manchon PVC

# Round PVC cables 2 x 0.75mm<sup>2</sup>

Câbles PVC rond

235833



White | Blanc

235841



Black | Noir

T 85°C

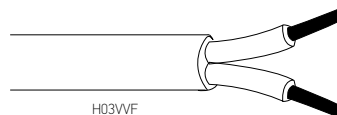

## Description

Diameter | Diamètre : Ø5.4mm

Length | Longueur : 100m

Cable type | Type de câble : H03VVF

PVC sleeve, PVC round outer cover | Manchon en PVC, enveloppe extérieure ronde en PVC

Double insulation | Double isolation

# Round PVC cables 3 x 0.75mm<sup>2</sup>

Câbles PVC rond

235913



White | Blanc

235921



Black | Noir

235927



Gold | Or

T 85°C

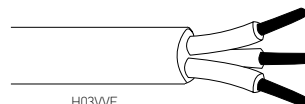

## Description

Diameter | Diamètre : Ø5.7mm

Length | Longueur : 100m

Cable type | Type de câble : H03VVF

PVC sleeve, PVC round outer cover | Manchon en PVC, enveloppe extérieure ronde en PVC

Double insulation | Double isolation

# Oval PVC cables 2 x 0.5mm<sup>2</sup>

Câbles PVC ovale

236243



White | Blanc

236251



Black | Noir

236257



Gold | Or

236285



Crystal | Cristal

T 85°C



**Description**

Dimensions (Ø x W) : Ø5.2 x 3.2mm

Length | Longueur : 100m

Cable type | Type de câble : H03VVH-2F

PVC sleeve, PVC oval outer cover | Manchon en PVC, enveloppe extérieure ovale en PVC

Double insulation | Double isolation

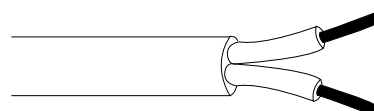

H03VVH-2F

# Oval PVC cables 2 x 0.75mm<sup>2</sup>

Câbles PVC ovale

236373



White | Blanc

236381



Black | Noir

236387



Gold | Or

236398



Crystal | Cristal

T 85°C



**Description**

Dimensions (Ø x W) : Ø5.5 x 3.5mm

Length | Longueur : 100m

Cable type | Type de câble : H03VVH-2F

PVC sleeve, PVC oval outer cover | Manchon en PVC, enveloppe extérieure ovale en PVC

Double insulation | Double isolation

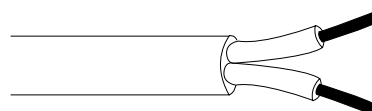

H03VVH-2F



# UL cables for USA 2 x 0.824mm<sup>2</sup>

Câbles UL pour USA

236403



Black | Noir

236411



White | Blanc

T 105°C

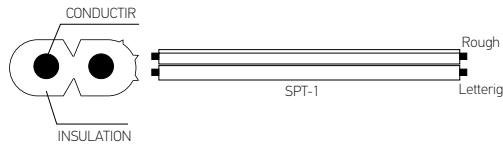

**Description**

Dimensions (Ø x W) : Ø5.4 x 2.7mm  
 Length | Longueur : 305m  
 Cable type | Type de câble : SPT1  
 Material | Matériau : PVC

# UL cables for USA 2 x 0.824mm<sup>2</sup>

Câbles UL pour USA

236413



Black | Noir

236421



White | Blanc

T 105°C

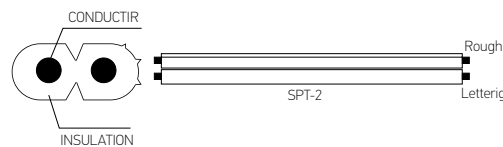

**Description**

Dimensions (Ø x W) : Ø6.9 x 3.5mm  
 Length | Longueur : 305m  
 Cable type | Type de câble : SPT2  
 Material | Matériau : PVC

# High temperature cable 1 x 0.75mm<sup>2</sup>

Câble haute température

236763



White | Blanc

T 250°C



ASE

**Description**

Diameter | Diamètre : Ø2.6mm  
 Length | Longueur : 100m  
 Cable type | Type de câble : ECSC  
 Finish | Finition : Silicon and fiberglass | Silicone et fibre de verre  
 Flexible cable, silicon sleeve, fiberglass sheath, VDE-ASE auto-extinguishable | Câble flexible, manchon en silicone, gaine en fibre de verre, VDE-ASE auto-extinguible

# High temperature cable 1 x 0.75mm<sup>2</sup>

Câble haute température

236853



White | Blanc

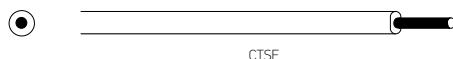

ASE

## Description

Diameter | Diamètre : Ø2.9mm  
 Length | Longueur : 100m  
 Cable type | Type de câble : CTSE  
 Finish | Finition : Silicon | Silicone  
 Double insulation | Double isolation  
 Flexible cable, silicon sleeve, silicon protective sheath, auto-extinguishable  
 Câble flexible, manchon en silicone, gaine de protection en silicone, auto-extinguible

# High temperature cable 1 x 0.75mm<sup>2</sup>

Câble haute température

236982



Crystal | Cristal



## Description

Diameter | Diamètre : Ø1mm  
 Length | Longueur : 100m  
 Cable type | Type de câble : AWG20  
 Finish | Finition : Teflon | Téflon  
 Flexible wire | Câble flexible

# PVC round high temperature cable 2 x 0.75mm<sup>2</sup>

Câble PVC rond haute température

236527



Gold | Or

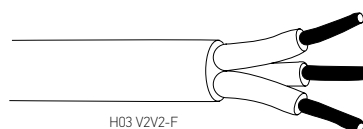

## Description

Diameter | Diamètre : Ø5.6mm  
 Length | Longueur : 100m  
 Cable type | Type de câble : H03V2V2-F  
 Double insulation | Double isolation

# Plastic power cord 2 x 0.75mm<sup>2</sup> (L. 3m with rocker switch and bipolar plug)

Cordon plastique fiche bipolaire et interrupteur à bascule

240511



Crystal | Cristal

**Description**

Length | Longueur : 3m

Cable type | Type de câble : H03VVH-2F

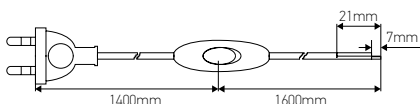

# Plastic power cords 2 x 0.75mm<sup>2</sup> (L. 1.5m with bipolar plug & rocker switch)

Cordons plastique fiche bipolaire et interrupteur à bascule

240523



White | Blanc

240531



Black | Noir

240540



Crystal | Cristal

240547



Gold | Or



**Description**

Length | Longueur : 1.5m

Cable type | Type de câble : H03VVH-2F

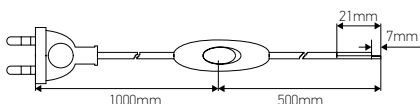

# Plastic power cords 2 x 0.75mm<sup>2</sup> (L. 2m with bipolar plug & rocker switch)

Cordons plastique fiche bipolaire et interrupteur à bascule

240573



White | Blanc

240581



Black | Noir

240580



Crystal | Cristal

240587



Gold | Or



**Description**

Length | Longueur : 2m

Cable type | Type de câble : H03VVH-2F

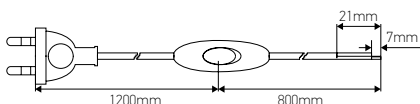

# Plastic power cords 2 x 0.75mm<sup>2</sup> (L. 1.5m with bipolar plug)

Cordons plastique fiche bipolaire

241001



Black | Noir

241013



White | Blanc

**Description**

Length | Longueur : 1.5m

Cable type | Type de câble : H03VVH-2F

Electro-welded fittings, crimped ends | Accessoires électro-soudés, extrémités serties



2.5A  
250V

T 70°C

100

**CABLE**  
EN 50525-2-11 2011  
CEI EN 50525-2-11 2012

**PLUG**  
EN50075  
IEC60884-1 3rd Ed. '02 A1 2006

# Plastic power cords 2 x 0.75mm<sup>2</sup> (L. 2m with bipolar plug)

Cordons plastique fiche bipolaire

241023



White | Blanc

241040



Crystal | Cristal

241041



Black | Noir

**Description**

Length | Longueur : 2m

Cable type | Type de câble : H03VVH-2F

Electro-welded fittings, crimped ends | Accessoires électro-soudés, extrémités serties



2.5A  
250V

T 70°C

100

**CABLE**  
EN 50525-2-11 2011  
CEI EN 50525-2-11 2012

**PLUG**  
EN50075  
IEC60884-1 3rd Ed. '02 A1 2006

# PVC power cord 3 x 1.5mm<sup>2</sup> (L. 2m with Schuko plug)

Cordon PVC fiche Schuko

241261



Black | Noir

60

**Description**

Length | Longueur : 2m

Cable type | Type de câble : H05VV-F

Double insulation | Double isolation

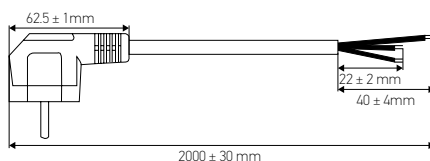

## Plastic power cords 2 x 0.75mm<sup>2</sup>

(L. 1.5m E14 lampholder with ring, rocker switch & bipolar plug)

Cordons plastique douille E14, interrupteur à bascule et fiche bipolaire

241293



White | Blanc

241297



Gold | Or



### Description

Length | Longueur : 1.5m

Distance between switch and plug | Distance entre l'interrupteur et la fiche : 1m

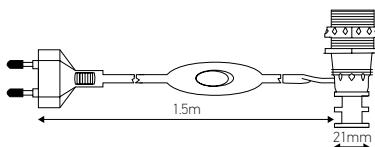

## Plastic power cords 2 x 0.75mm<sup>2</sup> (L. 3.5m with footswitch & bipolar plug)

Cordons plastique interrupteur à pied et fiche bipolaire

241313



White | Blanc

241321



Black | Noir

241327



Gold | Or

241350



Crystal | Cristal



### Description

Length | Longueur : 3.5m

Distance between switch and plug | Distance entre l'interrupteur et la fiche : 1m

## Plastic power cords 3 x 1mm<sup>2</sup> (L. 1.5m / L. 3m with Schuko plug)

Cordons plastique fiche Schuko

241361



Black | Noir



241371



Black | Noir

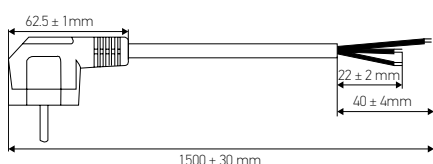

### Description

Length | Longueur : 1.5m

Cable type | Type de câble : H05VV-F

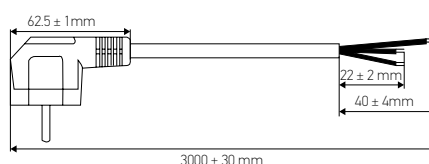

### Description

Length | Longueur : 3m

Cable type | Type de câble : H05VV-F

# Plastic power cords 3 x 0.75mm<sup>2</sup> (L. 2m with euro-Schuko double earth plug & switch)

Cordons plastique fiche Euro-Schuko double terre et interrupteur

241451



Black | Noir

241467



Gold | Or



**Description**

Length | Longueur : 2m

Distance between switch and plug | Distance entre l'interrupteur et la fiche : 1.20m

# Plastic power cord 3 x 0.75mm<sup>2</sup> (L. 3.5m with euro-Schuko double earth plug & switch)

Cordon plastique fiche Euro-Schuko double terre et interrupteur

241471



Black | Noir

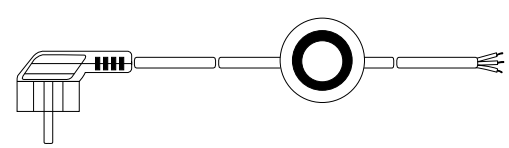

**Description**

Length | Longueur : 3.5m

Distance between switch and plug | Distance entre l'interrupteur et la fiche : 1m

## Plastic power cord 2 x 0.75mm<sup>2</sup> (L. 2m with UK plug & rocker switch)

Cordon plastique fiche UK et interrupteur à bascule

241541



Black | Noir

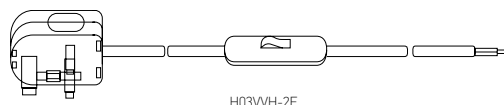

H03VVH-2F



50/200

### Description

Length | Longueur : 2m

Distance between switch and plug | Distance entre l'interrupteur et la fiche : 1.20m

Cable type | Type de câble : H03VVH-2F

## Plastic power cords 3 x 0.75mm<sup>2</sup> (L. 2m with Euro-Schuko double earth)

Cordons plastique fiche Euro-Schuko double terre

241563



241571

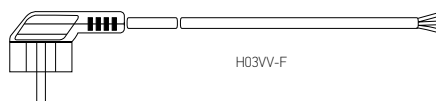

H03VV-F

10/16A  
250V



100

### Description

Length | Longueur : 2m

Cable type | Type de câble : H03VV-F

Crimped ends | Extrémités serties

## Plastic power cord 3 x 0.75mm<sup>2</sup> (L. 4m with euro-Schuko double earth)

Cordon plastique fiche Euro-Schuko double terre

241581

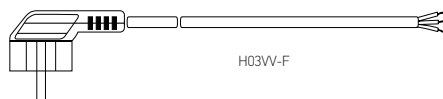

H03VV-F

10/16A  
250V



50

### Description

Length | Longueur : 4m

Cable type | Type de câble : H03VV-F

Crimped ends | Extrémités serties

# Textile power cords 2 x 0.75mm<sup>2</sup> (L. 2m with rocker switch & bipolar plug)

Cordons textile interrupteur à bascule et fiche bipolaire

241611



Black | Noir

241633



White | Blanc

241635



Grey | Gris



241636



Red | Rouge

241638



Green | Vert

241639



Orange

**Description**

Length | Longueur : 2m

Distance between switch and plug | Distance entre l'interrupteur et la fiche : 1.20m

Cable type | Type de câble : H03VVH2-F

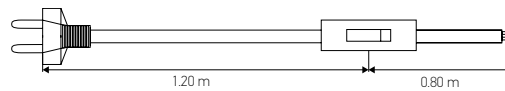

# UL plastic power cord for USA 2 x 0.824mm<sup>2</sup>

(L. 2m with bipolar plug)

Cordon plastique UL pour les EU fiche bipolaire

241671



Black | Noir

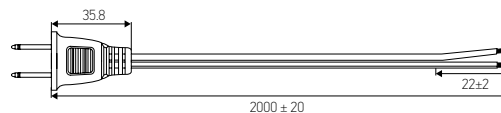

**Description**

Length | Longueur : 2m

Cable type | Type de câble : SPT-2 WW-1



# UL plastic power cords for USA 2 x 0.824mm<sup>2</sup>

(L. 2m with bipolar plug & slide switch)

Cordons plastique UL pour les EU fiche bipolaire et interrupteur à curseur

241683



White | Blanc

241691



Black | Noir

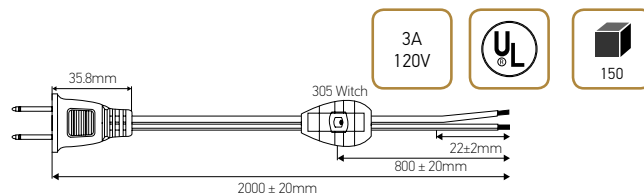

3A  
120V



150

**Description**

Length | Longueur : 2m

Cable type | Type de câble : SPT-2 WW-1

# PVC PSE power cord for Japan 2 x 0.75mm<sup>2</sup>

(L. 2m with bipolar plug & rotative switch)

Cordon PVC PSE pour le Japon fiche bipolaire et interrupteur à molette

241681



Black | Noir

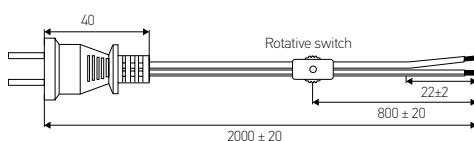

200

**Description**

Length | Longueur : 2m

Distance between switch and plug | Distance entre l'interrupteur et la fiche : 1.20m

Cable type | Type de câble : VFF

# Power cord with dimmer 2 x 0.75mm<sup>2</sup>

(L. 2m with bipolar plug & dimmer)

Cordon avec variateur

260011



Black | Noir

220-240V  
50/60Hz



10

**Description**

Length | Longueur : 2m

Distance between switch and plug | Distance entre l'interrupteur et la prise : 1.50m

Suitable for LED | Convient aux LED

Power range | Gamme de puissance : Halo 40/160W, LED 4/100W

# Power cords with dimmer 2 x 0.75mm<sup>2</sup>

(L. 2m with bipolar plug & dimmer)

Cordons avec variateur

261122



Black | Noir

261137



Gold | Or

261140



Transparent

2.5A  
250V

50

**Description**

Length | Longueur : 2m

Cable type | Type de câble : H03VVH2-F

Distance between switch and plug | Distance entre l'interrupteur et la fiche : 1.20 m

Not suitable for LED | Ne convient pas aux LED

Dimmer by button pressing (short press for instant swich On/Off - long press for gradual switch). LED for tracing in the dark. Memory recall of the last level of light intensity.

Variation par pression (courte pour Marche / Arrêt - longue pour l'allumage progressif). Veilleuse LED. Mémoire du dernier réglage d'intensité.

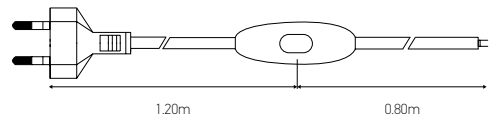

# Transparent heat-shrink sheath

Gaîne thermo-rétractable transparente

236974



Crystal | Cristal

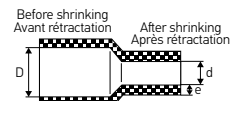

**Description**

Length | Longueur : 100m

Before shrinking | Avant rétractation : 7mm

After shrinking | Après rétractation : 4mm

Section : 1 x 0.7mm<sup>2</sup> - 1 x 0.4mm<sup>2</sup>

Plasticized PVC, Heat-shrink sleeve, transparent di-electric strength | PVC plastifié, manchon thermorétractable, résistance diélectrique transparente : 20KV/mm

Shrink temperature | Température de rétractation : 120°C

# High temperature sheath

Gaine haute température

236969



Brown | Brun

**Description**

Length | Longueur : 25m

Diameter | Diamètre : Ø5mm

Double layer insulation for two wire connection | Double isolation pour bifilaire

Silicone-coated fiberglass-auto-extinguishable | Fibre de verre siliconée - autoextinguible

Breakdown voltage | Tension de claquage : 2 kV

# Wire stripper

Pince à dénuder

390421



Black & white | Noir & blanc

## Description

2 in 1 wire stripper & cutter | Pince 2 en 1 pour couper et dénuder

Applicable wire stripper size: 0.2-6mm<sup>2</sup> | Dénudage: 0.2-6mm<sup>2</sup>

Self adjusting wire stripping mechanism | Mécanisme de réglage automatique pour le dénudage





# Switches & plugs

Interrupteurs et prises



# Bipolar switches

Interrupteurs bipolaires

155463



Transparent

155731



White | Blanc



EN 61058

## Description

Type : By hand | À main

Screw terminals | Bornes à vis

Cable to be used | Câble à utiliser : H03VVH2-F

Dimensions : 60 x 26 x 15mm

# Bipolar switches

Interrupteurs bipolaires

155733



Black | Noir

155735



Gold | Or



EN 61058

## Description

Type : By hand | À main

Screw terminals | Bornes à vis

Cable to be used | Câble à utiliser : H03VVH2-F

Dimensions : 60 x 26 x 15mm

# Bipolar switches

Interrupteurs bipolaires

155736



White | Blanc

155737



Black | Noir

155738



Gold | Or



EN 61058

## Description

Type : By hand | À main

Screw terminals | Bornes à vis

Cable to be used | Câble à utiliser : H03VVH2-F, H03VV-F

Dimensions : 60 x 26 x 15mm

# Bipolar switches

Interrupteurs bipolaires

246751



White | Blanc

246763



Black | Noir

246777



Gold | Or

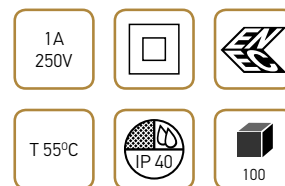

EN 61058-1

## Description

Type : By hand | À main

Slide switch | Interrupteur à curseur

Brass contacts | Contacts laiton

Screw terminals | Bornes à vis

Cable to be used | Câble à utiliser : H03VH2-F

Connection for neutral | Connexion pour neutre

Dimensions : 55 x 24 x 15mm

# Bipolar rocker switches

Interrupteurs bipolaires à bascule

246941



Black | Noir

246953



White | Blanc

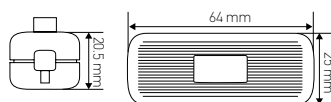

EN 61058-1

## Description

Type : By hand | À main

Brass contacts | Contacts laiton

Screw terminals | Bornes à vis

Clip together case | Boîtier clipsable

Earth terminal | Avec Terre

Cables to be used | Câbles à utiliser : H03VVF

Dimensions : 64 x 25 x 20.5mm

# Bipolar switches with luminescent sensor

Interrupteurs bipolaires à touche lumineuse

247023



White | Blanc

247031



Black | Noir

247032



Brown | Marron

247037



Gold | Or

247045



Grey | Gris

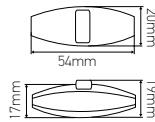

EN 61058-1

**Description**

Type : By hand | À main  
 Material | Matériau : Nylon  
 Dimensions : 54 x 20 x 17mm

# Bipolar switches

Interrupteurs bipolaires

247153



White | Blanc

247161



Black | Noir

247162



Brown | Marron

247167



Gold | Or

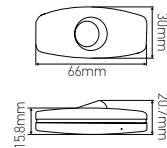

**Description**

Type : By hand | À main  
 For class II devices, cable clamps, screw terminals, closure by clipping | Pour appareils de classe II, serre-câble, bornes à vis, fermeture par clipsage  
 Cable to be used | Câble à utiliser : H03VH2-F  
 Dimensions : 66 x 15.8 x 20.7mm



# Pushbutton switches

Interrupteurs à poussoir

245115

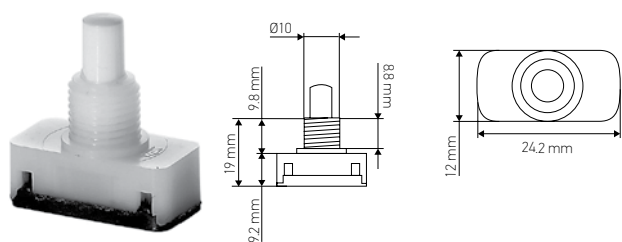

White | Blanc

## Description

Type : By hand | À main  
Screw terminals | Bornes à vis  
Dimensions : 24.2 x 12 x 9.2mm



EN 61058-1

245209



White | Blanc

## Description

Type : By hand | À main  
Screw terminals | Bornes à vis  
Dimensions : 24.2 x 12 x 9.7mm



EN 61058-1

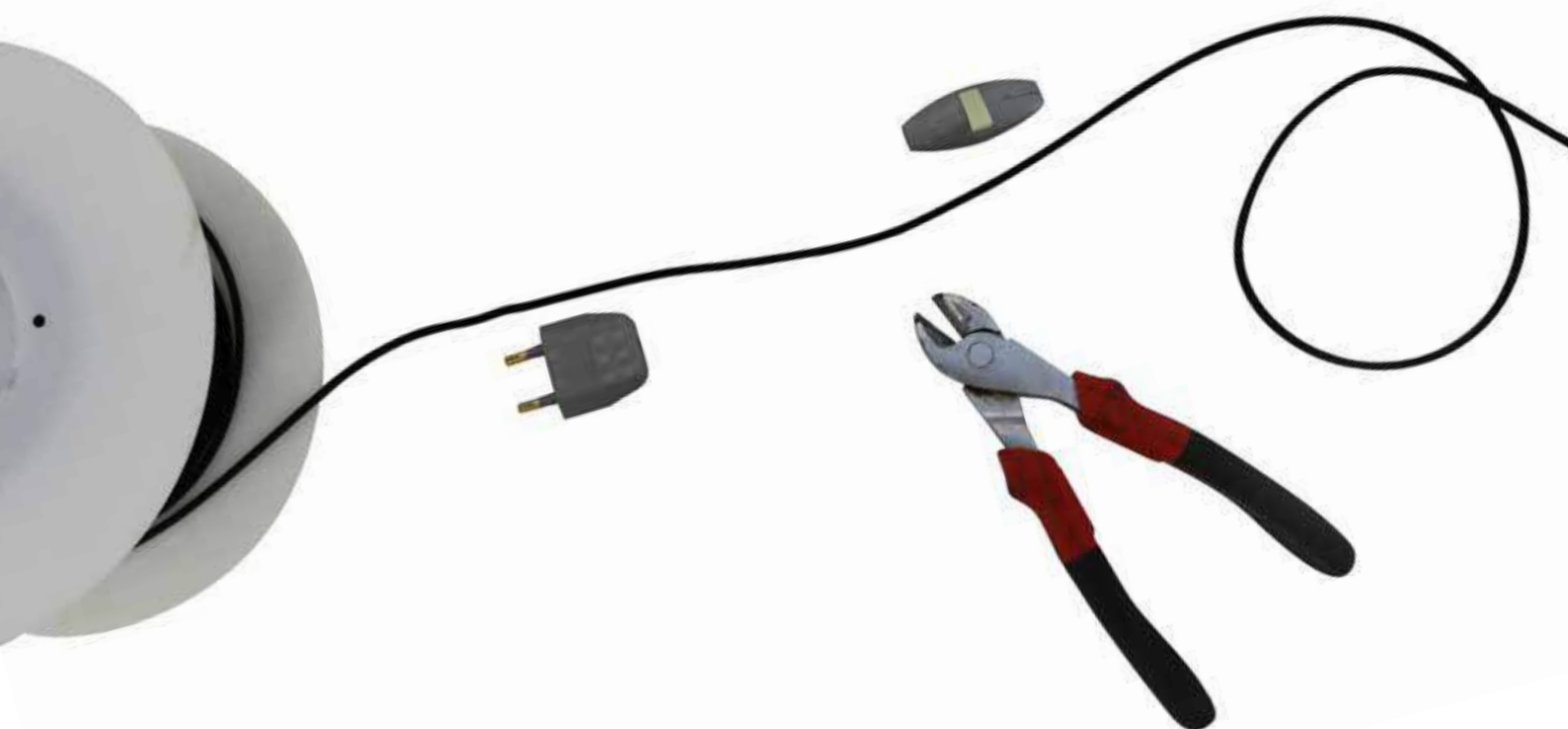

# Pull switch

Interrupteur unipolaire à tirette

245760

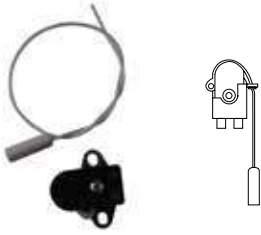

2A 250V		T 125°C
	100	

UL 1054  
EN 61058-1  
CSA C22.2

**Description**

Type : By hand | À main  
Dimensions : 15 x 15 x 27.5mm

245795



2A 250V		T 125°C
	100	

EN 61058-1

**Description**

Type : By hand | À main  
Plate with 2 holes | Plaque à 2 trous  
Dimensions : 27.5 x 15 x 11.4mm

## Unipolar rocker switches mounting by clipping and screw terminals

Interrupteurs unipolaires à bascule fixation par clipsage et bornes à vis

245801



Black | Noir

245803



White | Blanc

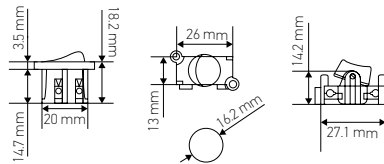

2A 250V		T 125°C
		100/3000

EN 61058-1

**Description**

Type : By hand | À main  
Dimensions : 26.5 x 16.3 x 14.7mm

## Unipolar rocker switches screw fixing & crimp terminals

Interrupteurs unipolaire à bascule fixation par vis et bornes à sertir

245821



Black | Noir

245823



White | Blanc

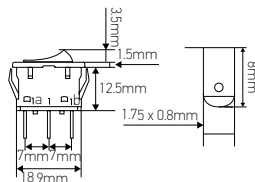

10A 250V		T 85°C
		100

**Description**

Type : Recessed | À encastrer  
Crimp terminals | Bornes à sertir : 4.8 / 0.8mm

# Foot switches Ø65mm with earth

Interrupteurs à pied avec terre

246051



Black | Noir

246063



White | Blanc

246077



Gold | Or

246088



Transparent

2A  
250V



**Description**

Type : On foot | À pied  
 Screw terminals | Bornes à vis  
 Internal cable clamp | Serre-câble intérieur  
 Cable to be used | Câble à utiliser : H03VV-F  
 Dimensions (Ø x H) : Ø65 x 23mm

# Toggle switch with knurled ring & locking nut

Interrupteur « tumbler » avec bague moletée et contre-écrou

247315

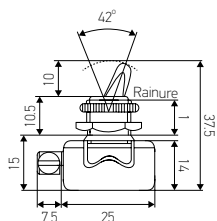

T 125°C



**Description**

Type : By hand | À main  
 Knurled ring & locking nut internal Ø12mm | Bague moletée & écrou de blocage int. Ø12mm  
 Dimensions (W x H) : 25 x 37.5mm

247325

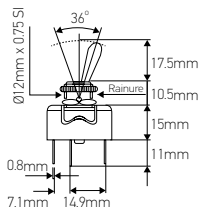

T 125°C



**Description**

Type : By hand | À main  
 Knurled ring & locking nut internal Ø12mm, nickel-plated handle | Bague moletée & écrou de blocage int. Ø12mm, manette nickelée  
 Dimensions (W x H) : 23.6 x 43mm

# Conical ring for pushbutton switch

Bague conique pour interrupteur à poussoir

245443



White | Blanc

## Description

Material | Matériau : Polystyrene

Height | Hauteur : 7mm

Bronze contacts - Push in terminals | Contacts en bronze - Bornes à poussoir

Dimensions : 24.2 x 12 x 19mm



EN 61058-1

UL 1054

CSA C22.2

# Conical rings for pushbutton switches

Bagues coniques pour interrupteurs à poussoir

245457



Brass | Laiton

245465



Nickel-plated brass | Laiton nickelé

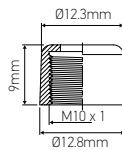

## Description

Height | Hauteur : 9mm

Diameter | Diamètre : Ø12.8mm

# Locking nut

Contre-écrou

245695



Stamped steel  
Acier découpé

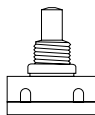

## Description

Diameter | Diamètre : Ø12.3mm

# Universal foot dimmer

Variateur universel à pied

158854



Black | Noir

## Description

Power | Puissance : 4 - 250W

Slider | Curseur

Dimensions : Ø100 x 28.7mm



# LED foot dimmer

Variateur LED à pied

158860



Black | Noir

## Description

Power | Puissance : 1 - 85W

Built in push button | Bouton poussoir intégré

Dimensions : Ø65 x 31.2mm



# Foot dimmer with slider

Variateur à pied avec curseur

260649



Transparent

## Description

Power | Puissance : 60 - 500W 230V

Linear potentiometer | Potentiomètre linéaire

Dimensions : 115 x 71 x 39mm



# Foot dimmers with slider

Variateurs à pied avec curseur

260532



Black | Noir

260533



White | Blanc

260537



Gold | Or



## Description

Power | Puissance : 60 - 500W  
 Linear potentiometer | Potentiomètre linéaire  
 Protection fuse | Fusible de protection  
 Light indicator | Indicateur lumineux  
 Dimensions : 115 x 71 x 39mm

# Foot dimmer with slider

Variateur à pied avec curseur

260622



Black | Noir

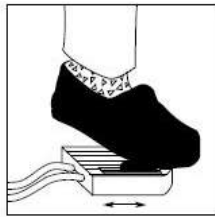

## Description

Power | Puissance : 60 - 300W  
 Linear potentiometer | Potentiomètre linéaire  
 Protection fuse | Fusible de protection  
 Light indicator | Indicateur lumineux  
 Dimensions : 115 x 71 x 39mm

# Foot dimmers with slider

Variateurs à pied avec curseur

260721



Black | Noir

260723



White | Blanc

260727



Gold | Or



## Description

Power | Puissance : halogène 40-250W, LED 4-100W  
 Trailing edge technology | Technologie de pointe  
 Dimensions : 115 x 71 x 39mm

## Foot dimmer with slider

Variateur à pied avec curseur

260821



Black | Noir

Power | Puissance : halogène 40-250W, LED 4-100W  
Trailing edge technology | Technologie de pointe  
Dimensions : 109 x 61 x 33mm



266768



Black | Noir

Power | Puissance : 20-60W  
Linear Potentiometer | Potentiomètre linéaire  
Dimensions : 109 x 61 x 33mm



## Foot dimmer with slider

Variateur à pied avec curseur

260929



Black | Noir

### Description

Power | Puissance : 60 - 500W  
Interrupteur | Switch : 2.5 A  
Linear potentiometer | Potentiomètre linéaire  
Protection fuse | Fusible de protection  
Light indicator | Indicateur lumineux  
Dimensions : 110 x 71 x 38mm

230V

## Hand dimmers with slider

Variateurs à main avec curseur

261023



White | Blanc

261031



Black | Noir

230V

50

### Description

Power | Puissance : 40-150W  
Rotary potentiometer | Potentiomètre rotatif  
Protection fuse | Fusible de protection  
Dimensions : 92 x 27 x 28mm

# LED hand dimmer

Variateur LED à main

158852



Transparent

## Description

Power | Puissance : 1-20W

Built-in-push button | Bouton poussoir intégré

Dimensions : 70 x 28.8 x 18.1mm



# Universal hand dimmer

Variateur universel à main

158858



Black | Noir

## Description

Power | Puissance : 4 - 25W

Dimensions : 96.5 x 30.5 x 27.1mm



# LED and halogen hand dimmers

Variateurs LED et halogène à main

260001



Black | Noir

260002



Transparent

260003



White | Blanc

260007



Gold | Or

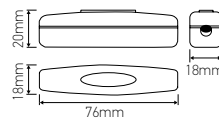

## Description

Continuous regulation | Régulation continue

Soft start (anti-glare) & soft stop | Démarrage et arrêt progressifs (anti-éblouissement)

Cable to be used | Câble à utiliser : H03VV-F

Power : Halogen : 25-160W, LED : 4-25W

Dimensions : 76 x 18 x 20mm



# Recessed contactor

Contacteur à encastrer

247652



White | Blanc



## Description

"Refrigerator" type contact opening by push-in hole terminals | Type « réfrigérateur » contacteur encastré par des bornes de passage

# Contactors

Contacteurs

247761



Black | Noir

247763



White | Blanc

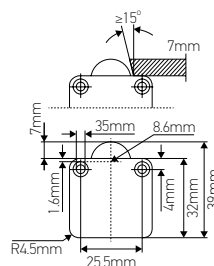

## Description

Type : Recessed | Encastré  
Contact opening by wheel | Contact par molette  
Dimensions : 39 x 25.5mm

# Male plugs

Fiches mâles

250554



Gold | Or

250555



Black | Noir

250556



White | Blanc

250557



Transparent

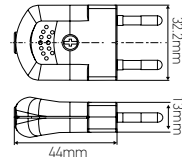

10A  
250V

IP 20

100

**Description**

Cable to be used | Câble à utiliser : H03VV-F, H03VH2-F  
Screw terminals | Bornes à vis  
Dimensions : 32.2 x 13 x 44mm

250553



White | Blanc

250561



Black | Noir

250562



Brown | Marron

250565



Silver | Argent

250567



Gold | Or

6A  
250V

CE

RoHS

50

NF C-61314  
REACH

**Description**

Cable to be used | Câble à utiliser : H03VVH-2F  
Internal cable clamp | Serre-câble intérieur  
Closure by clipping | Fermeture par clipsage  
Dimensions : 15.2 x 36 x 51.5mm

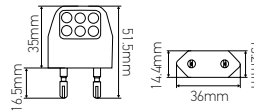

250571



Black | Noir

250573



White | Blanc

250577



Gold | Or

6A  
250V

IP 20

**Description**

Cable to be used | Câble à utiliser : 0.75mm<sup>2</sup>  
Dimensions : 35.5 x 14 x 60mm

# Bipolar plugs + Earth

Fiches bipolaires + Terre

250881

250883

250887



Black | Noir



White | Blanc



Gold | Or

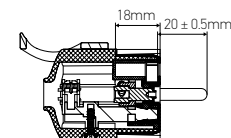
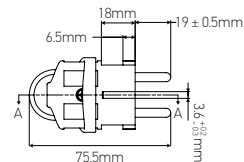
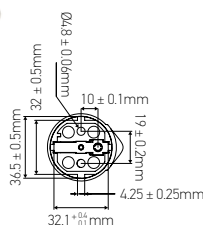

## Description

Cable to be used | Câble à utiliser : 0.75 - 1.5mm<sup>2</sup>  
 Dimensions (Ø x H) : Ø35 x 75.5mm

250781

250786



Black | Noir



White | Blanc



## Description

Pins | Broches : Ø4.8mm  
 With protection blocks | Avec éclipses de protection

250891

250893

250897



Black | Noir



White | Blanc



Gold | Or

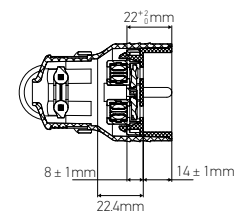
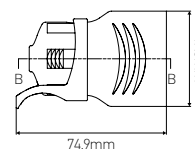
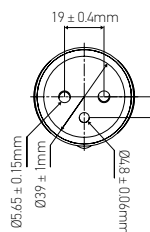

## Description

Cable to be used | Câble à utiliser : 0.75 - 1.5mm<sup>2</sup>  
 Dimensions (Ø x H) : Ø47.5 x 74.9mm

# 6 outlet extension cord

Socle prolongateur 6 prises aluminium

252111



Aluminium



## Description

Number of sockets | Nombre de prises : 6  
 With cable | Avec câble : H05VV-F 3G 1.0mm<sup>2</sup>  
 Max watt : 3680W 250V ~ 50Hz

## Multi sockets

Bloc multiprises

158709



Black | Noir  
 4 Outlets | 4 Prises

158707



Black | Noir  
 2 Outlets | 2 Prises

158705



Black & grey | Noir & gris  
 4 Outlets | 4 Prises

158703



Black & grey | Noir & gris  
 3 Outlets | 3 Prises

# Euro-Shuko plug

Fiche Euro-Shuko

250761



White | Blanc

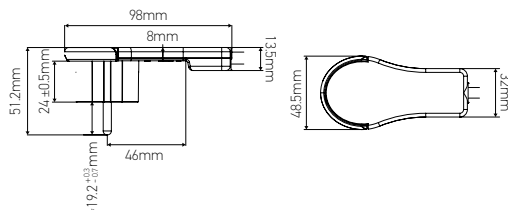

16A  
250V



## Description

Cable to be used | Câble à utiliser : 0.75mm<sup>2</sup>  
Dimensions : 51.2 x 48.5 x 98mm

# Bipolar Swiss plug + Earth

Fiche Suisse bipolaire + Terre

250721



Black | Noir

10A  
250V



## Description

Integrated cable clamp | Serre-câble intégré  
Cable to be used | Câble à utiliser : H03VV-F

# Bipolar UK plugs + Earth

Fiches bipolaires UK + Terre

250771



Black | Noir

250773



White | Blanc

3A  
250V



## Description

3A fuse | Fusible 3A  
Integrated cable clamp | Serre-câble intégré  
Cable to be used | Câble à utiliser : H03VV-F

# Adaptors plugs EU - UK

Adaptateurs de fiches EU - UK

251671



Black | Noir

251687



White | Blanc



## Description

Material : Thermoplastic PP | Matériau : Thermoplastique PP

# Adaptor plug EU - UK

Adaptateur de fiche EU - UK

158657



White | Blanc



## Description

Material | Matériau : Thermoplastic PP | Thermoplastique PP

Converting a 2.5A Europe plug into 3-pin UK plug | Adaptation d'une fiche 2,5A européenne en fiche britannique 3 broches  
240VAC/50Hz - 13A - Max 3000W

# Universal mural dimmer

Variateur mural universel

260623



White | Blanc

## Description

Power | Puissance : 3 - 400W

Cable to be used | Câble à utiliser : max. 2 x 2.5mm<sup>2</sup>

Dimensions (W x H) : 45 x 45mm



C 61-314:2008  
A1:2010

# LED mural dimmer

Variateur LED mural

260624



White | Blanc

## Description

Power | Puissance : 4-160W

Diameter | Diamètre : Ø65mm



# LED and halogen DIN dimmer

Variateur DIN LED et halogen

260625



White | Blanc

## Description

Power | Puissance : Halogen 25-600W, LED 10-400W

Dimmer for DIN track | Gradateur pour piste DIN

Trailing edge technology | Technologie de pointe

Soft start | Démarrage progressif

Protection : Thermal, over load and short circuit | Protection : Thermique, surcharge et court-circuit



# Recessed LED dimmer

Variateur LED à encastrer

260626



White | Blanc

## Description

Power | Puissance : Halogen : 4-250W, LED : 4-100W

Universal electronic regulator for push button | Régulateur électronique universel pour bouton-poussoir

Installation in junction boxes | Installation dans des boîtes de jonction

Soft start - soft stop | Démarrage progressif - arrêt progressif

# Universal adaptor EU - UK - USA + 2 USB

Adaptateur universel

252002



Black | Noir



## Description

Built-in 6A fuse | Fusible 6A incorporé

Dimensions : 61 x 46 x 58mm

# Connection device for lights

Dispositif de connexion pour luminaire

253003



White | Blanc



EN 61184  
UTE C 61390  
NF C 61601

253013



White | Blanc



## Description

Material | Matériau : Thermoplastic | Thermoplastique

Connection by screw terminal | Borne à vis

Cable to be used | Câble à utiliser : 0,5 to 1mm<sup>2</sup>

## Description

Finish | Finition : Thermoplastic | Thermoplastique

Bipolar white thermoplastic lampholder with removable 2 - pole plug + earth for the subsequent connection of a class I or II for B22 - 75W max

Douille thermoplastique blanc avec fiche détachable 2 pôles + terre pour le raccordement ultérieur d'un luminaire classe I ou II pour lampe B22 - 75W maxi



# 180° infrared motion sensor

Détecteur de présence à infrarouges 180°

164801



White | Blanc

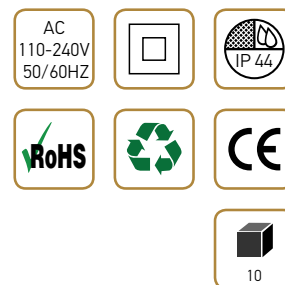

## Description

Ambient light | Lumière ambiante : <10Lux-2000 Lux

Detection angle | Angle de détection : 180°

Detection range | Portée de détection : 12m(22-24°C)

Time setting | Réglage de l'heure : 5 s-7 min

Rated load | Charge nominale : 1200W.Max

# 360° infrared motion sensor

Détecteur de présence à infrarouges 360°

164809



White | Blanc

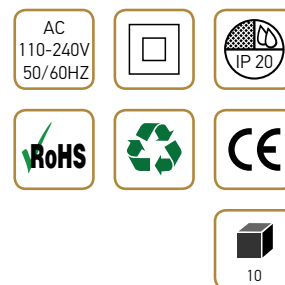

## Description

Ambient light | Lumière ambiante : <10Lux-2000 Lux

Detection angle | Angle de détection : 360°

Detection range | Distance de détection : 6 m(<24°C)

Time setting | Délai de déclenchement : min 10 s ± 3 s / Max : 7 min ± 2 min

Rated load | Puissance maximale de la lampe : 1200W (incandescent lamp) / 300W (energy-saving lamp)

Vitesse de détection de mouvement : 0.6-1.5m/s

# 360° recessed infrared motion sensor

Détecteur de présence à infrarouges 360° encastrable

164811



White | Blanc

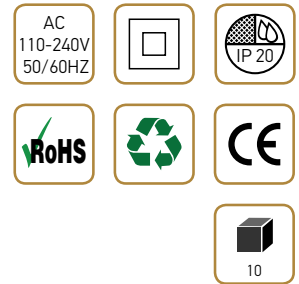

## Description

Ambient light | Lumière ambiante : <10Lux-2000 Lux

Detection angle | Angle de détection : 360°

Detection range | Distance de détection : 6m(<24°C)

Rated load | Puissance maximale de la lampe : 1200W

Time setting | Délai de déclenchement : 5s-10 min

# 160° infrared motion sensor

Détecteur de présence à infrarouges 160°

164812



White | Blanc



## Description

Ambient light | Lumière ambiante : <10Lux-2000 Lux (adjustable)

Detection angle | Angle de détection : 160°

Detection range | Distance de détection : 2-10m max (<24°C)

Time setting | Délai de déclenchement : Min.10 s ± 3sec / Max.7min ± 2min

Vitesse de détection de mouvement : 0.6-1.5m/s

Installing height | Hauteur d'installation : 1-1.8m





# Adaptors

Adaptateurs



# Adaptors for lampholders 60W max.

Adaptateurs pour douilles



EN 60238:2004  
A1:2008

158265

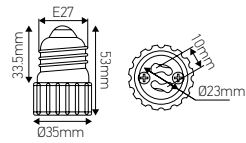

White | Blanc  
E27 => GU10  
Ceramic | Céramique

158267

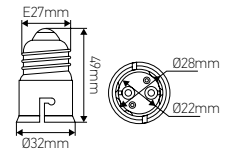

White | Blanc  
E27 => B22  
Plastic | Plastique

158269

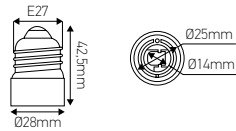

White | Blanc  
E27 => E14  
Plastic | Plastique

158459

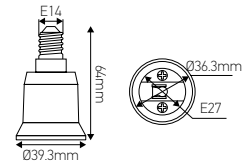

White | Blanc  
E14 => E27  
Plastic | Plastique

158461

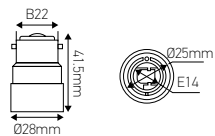

White | Blanc  
B22 => E14  
Plastic | Plastique

158463

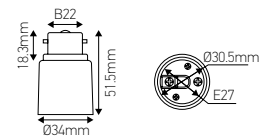

White | Blanc  
B22 => E27  
Plastic | Plastique

158465

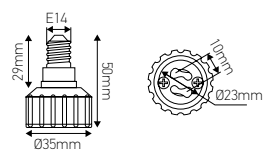

White | Blanc  
E14 => GU10  
Ceramic | Céramique

Maximum power | Puissance maxi : 60W  
Other versions available on request | Autres versions disponibles sur demande







# Drivers

Convertisseurs



# Halogen driver 230V 10-60W

Convertisseur halogène 230V 10-60W

266015



White | Blanc

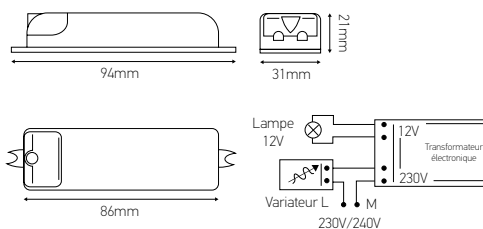

EN 61347

## Description

Can be used with dimmer | Utilisable avec variateur

Protection : Overload, overvoltage, short circuit | Protection : Surcharge, surtension, court-circuit

Input and output terminals on the same side | Borniers d'entrée et de sortie du même côté

Screw terminals | Bornes à vis : 2,5mm<sup>2</sup>

For cables | Pour câbles : Ø3 - 8mm

Power | Puissance : 10-60W

Dimensions : 86 x 31 x 21mm

# Halogen driver 230V 10-50W

Convertisseur halogène 230V 10-50W

266127



Black | Noir

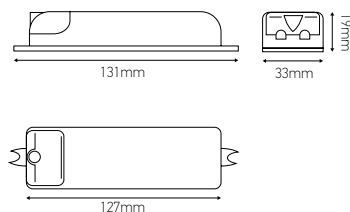

EN 61347

## Description

Dimmable by potentiometer | Dimmable avec potentiomètre

Protection : Overload, overvoltage, short circuit | Protection : Surcharge, surtension, court-circuit

Input and output terminals on the same side | Borniers d'entrée et de sortie du même côté

Screw terminals | Bornes à vis : 2,5mm<sup>2</sup>

For cables | Pour câbles : Ø3 - 6mm

Power | Puissance : 10-50W

Dimensions : 127 x 33 x 19mm

# Halogen driver 230V 35-105 W

Convertisseur halogène 230V 35-105 W

266246



White | Blanc

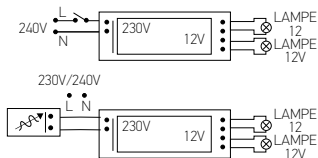
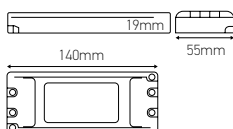

EN 61347

## Description

Protection : Overload, overvoltage, short circuit | Protection : Surcharge, surtension, court-circuit

Opposed input and output terminals | Borniers d'entrée et de sortie opposées

For cables | Pour câbles : Ø3 - 5mm

Power | Puissance : 35-105W

Dimensions : 140 x 55 x 19mm

# Halogen driver with potentiometer 230V 20-120W

Convertisseur halogène avec potentiomètre 230V 20-120W

266396



White | Blanc

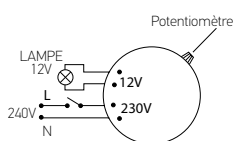

EN 61347

## Description

Protection : Overload, overvoltage, short circuit | Protection : Surcharge, surtension, court-circuit

Hole | Trou : 10mm

Input and output terminals on the same side | Borniers d'entrée et de sortie du même côté

Screw terminals | Bornes à vis : 2,5mm<sup>2</sup>

For cables | Pour câbles : Ø3 - 6mm

Power | Puissance : 20-120W

Dimensions : Ø88 x 32mm

# Halogen driver with potentiometer 230V 20-70W

Convertisseur halogène avec potentiomètre 230V 20-70W

266401



White | Blanc



EN 61347

## Description

Dimmable by leading or trailing edge dimmer | Compatible avec la plupart des dimmers

Protection : short circuit, overheating | Protection : court-circuit, surchauffe

Hole | Trou : 22mm

Power | Puissance : 20-70W

Diameter | Diamètre : Ø53mm

# Halogen driver with potentiometer 230V 35-105 W

Convertisseur halogène avec potentiomètre 230V 35-105 W

266503



White | Blanc



EN 61347

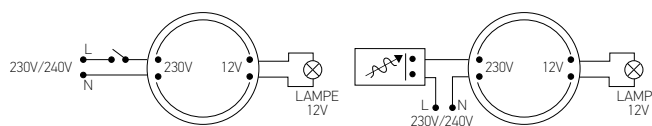

## Description

Protection : Overload, overvoltage, short circuit | Protection : Surcharge, surtension, court-circuit

Adjusting the end of phase (IGBT) - at the beginning of phase (triac) | Réglage en fin de phase (igbt) - en début de phase (triac)

Supplied with cables on the primary and secondary | Fourni avec câbles sur le primaire et le secondaire

Power | Puissance : 35-105W

Dimensions : Ø70 x 22mm

# LED and halogen driver 12V-1A 50-70W

Convertisseur LED et halogène 12V-1A 50-70W

158498



White | Blanc

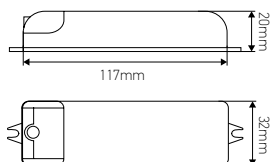

EN55015  
EN60598-1  
EN61000-3-2  
EN61347-1  
EN61347-2-2  
EN61547  
VDE0710-T14

## Description

Protection : overload, overvoltage, short circuit, overheating | Protection : surcharge, surtension, court-circuit, surchauffe  
Power : 1-50W for MR16 LED and 1-70W for MR16 Halogen | Puissance : 1-50W pour LED MR16 et 1-70W pour halogène MR16  
Dimensions : 117 x 32 x 20mm

# LED and halogen driver 12V-1A 50-70W

Convertisseur LED et halogène 12V-1A 50-70W

158844



White | Blanc

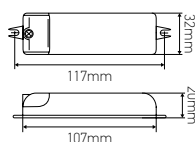

EN55015  
EN60598-1  
EN61000-3-2  
EN61347-1  
EN61347-2-2  
EN61547  
VDE0710-T14

## Description

Protection : overload, overvoltage, short circuit, overheating | Protection : surcharge, surtension, court-circuit, surchauffe  
Power : 1-50W for MR16 LED and 1-70W for MR16 Halogen | Puissance : 1-50W pour LED MR16 et 1-70W pour halogène MR16  
Input and output blocks on the same side | Borniers d'entrée et de sortie du même côté  
Dimensions : 117 x 32 x 20mm

# LED driver 12V - 1.25A DC/15 W

Convertisseur LED 12V - 1.25A DC/15 W

268849

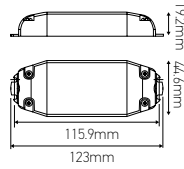

White | Blanc

EN61347-2-13  
EN61347-1  
EN62493  
EN61347-2-13  
EN55015  
EN61547  
EN6000-3-2  
EN6000-3-3

## Description

Protection : overload, overheating, short circuit (automatic restart) | Protection : surcharge, surchauffe, court-circuit (redemarrage automatique)

Power | Puissance : DC/15W

Dimensions : 123 x 44.6 x 19.2mm

# LED driver 12V - 5A 60W + cordon CL I

Convertisseur LED 12V - 5A 60W + cordon CL I

155556



Black | Noir

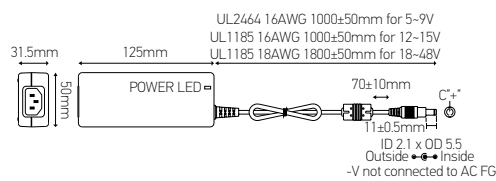

EN55022  
EN55032  
EN55024  
EN61204-3  
EN61000-3-2  
EN61000-3-3

## Description

Power | Puissance : 60W

Protection : overload, overvoltage, short circuit, overheating | Protection : surcharge, surtension, court-circuit, surchauffe

LED indicator for power on | Indicateur LED pour la mise sous tension

Dimensions : 125 x 50 x 31.5mm

# LED driver 12V - 2A DC/25 W

Convertisseur LED 12V - 2A DC/25 W

158339



White | Blanc

## Description

Protection : short circuit | Protection : court-circuit  
Power | Puissance : DC/25W

# Multi-outlets LED driver 12V

Convertisseur LED multi-sorties 12V

156629



White | Blanc

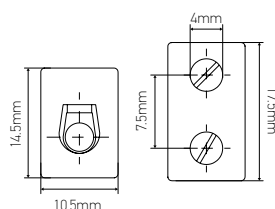

EN61347-1  
EN61347-2-13  
EN55015  
EN6100-3-2  
EN6100-3-3  
EN61547  
EN62384  
EN50172 (VDE0108)

## Description

Input voltage | Tension d'entrée : AC 110 - 240V

Output voltage | Tension de sortie : DC 12 V

Protection : overload, overvoltage, short circuit, overheating | Protection : surcharge, surtension, court-circuit, surchauffe

Dimensions : 124 x 79 x 22mm

W	V. Out DC	I Out DC	N° LED
25	80V Max.	350mA Cost	20
25	80V Max.	500mA Cost	20
50	80V Max.	700mA Cost	18
50	50V Max.	1A Cost	14
50	36V Max.	1,4A Cost	9
30	24V Cost	1,4A Max.	-
50	48V Cost	1A Max	-

# LED driver 350mA-12.5V-3W

Convertisseur LED

268861



Black | Noir

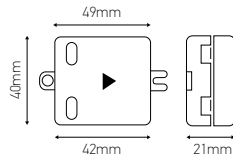

EN61347-1  
EN61347-2-13  
EN55015  
EN6100-3-2  
EN61547  
EN62384

## Description

Protection : overload, overvoltage, short circuit, overheating | Protection : surcharge, surtension, court-circuit, surchauffe  
Constant Current | Courant constant  
Dimensions : 42 x 40 x 21mm

# LED wall driver with switch

Convertisseur LED mural avec interrupteur

158479



Transparent

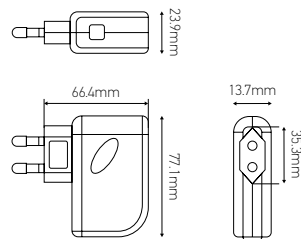

EN61347-1  
EN61347-2-13  
EN55015  
EN6100-3-2  
EN61547

## Description

Power | Puissance : 12W  
Input voltage | Tension d'entrée : AC 230V  
Output voltage | Tension de sortie : DC 12 V  
2m transparent cord with switch | Cordon transparent 2m avec interrupteur  
Protection : Overload, overvoltage, short circuit, overheating | Protection : Surcharge, surtension, court-circuit, surchauffe  
Dimensions : 77 x 66 x 14mm







# Metallic parts for lighting

Pièces métalliques



# S - hooks

Esses

280133



Height | Hauteur : 33mm  
Nickel-plated steel  
Acier nickelé

280141



Height | Hauteur : 41mm  
Nickel-plated steel  
Acier nickelé

280041



Height | Hauteur : 41mm  
Scoured brass  
Laiton décapé

280054



Height | Hauteur : 54mm  
Scoured brass  
Laiton décapé



# Clapper rings

Bélières

281168



Height | Hauteur : 23mm

281381



Height | Hauteur : 30mm

## Description

Finish | Finition : Zinc-plated stamped steel | Acier découpé zingué  
10 x 1 Female thread | Femelle 10 x 1



# Clapper ring

Bélière

281492



Height | Hauteur : 34mm



## Description

Finish | Finition : Zinc-plated stamped steel | Acier découpé zingué  
With locking screw & earth terminals | Avec vis de blocage et borne de mise à la terre

# Slip rings

Bagues coulissantes

281503



Ø10mm

281836



Ø11mm



**Description**

Material | Matériau : Brass | Laiton

With locking screw for Ø10/11mm looped stems | Avec vis d'arrêt pour tube Ø10/11mm

# Looped stems with cable passage

Tubes pour pavillons

282027



Height | Hauteur : 70mm  
Scoured brass | Laiton décapé

282039



Height | Hauteur : 90mm  
Scoured brass | Laiton décapé

282049



Height | Hauteur : 90mm  
Antique brass | Laiton patiné

282171



Height | Hauteur : 90mm  
Chrome-plated brass | Laiton chromé



**Description**

Diameter | Diamètre : Ø10mm

10 x 1 Male thread | Mâle 10 x 1

# Ceiling cups

Pavillons

283884



Chrome-plated brass  
Laiton chromé

283895



Polished lacquered brass  
Laiton poli verni



282963



Steel | Acier



**Description**

Dimensions (Ø x H) : Ø107 x 50mm

Hole | Trou : Ø11mm

**Description**

Dimensions (Ø x H) : Ø108 x 60mm

For Ø10mm tube | Pour tube Ø10mm

# Ceiling cup with brass beading

Pavillon à godron

283396



Brushed lacquered brass | Laiton brossé verni

## Description

Dimensions (Ø x H) : Ø100 x 60mm

# Ceiling cups

Pavillons

282841



Brushed lacquered brass  
Laiton brossé verni

282852



Raw brass | Laiton brut



## Description

Dimensions (Ø x H) : Ø89 x 45mm

# Figaro chains, non-welded

Chaînes Figaro, non soudées

285664

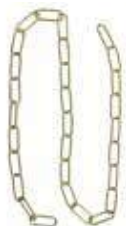

Brass-plated steel | Acier laitonné

285678



Antique steel | Acier patiné



**Description**

Links | Maillons : 34mm

Wire thickness | Epaisseur du fil : Ø2.8mm

## Oval chains

Chaînes ovales

285953



Scoured brass | Laiton décapé

**Description**

Links | Maillons : 25mm

286230



Brass-plated steel | Acier laitonné

**Description**

Links | Maillons : 30mm

Wire thickness | Epaisseur du fil : Ø3.4mm



## Oval dutch chain

Chaîne ovale hollandaise

285831



Brass | Laiton

**Description**

Links | Maillons : 42mm



## Die stamped chain

Chaîne matricée

285196



Brass | Laiton

**Description**

Links | Maillons : 60mm

Max. : 90Kgs



## Cast brass chain

Chaîne fondue

285531



Brass | Laiton

**Description**

Links | Maillons : 36mm

Empire style | Style empire



# Loops

Anneaux

287372



Brass | Laiton

**Description**

Internal Ø | Ø intérieur : 20mm  
 Height | Hauteur : 39mm  
 Movable, 10 x 1 male bushing, supported weight 1kg  
 Mobile, raccord mâle 10 x 1, poids supporté 1kg

287594



Brass | Laiton

**Description**

Internal Ø | Ø intérieur : 27mm  
 Height | Hauteur : 42mm  
 Movable, 10 x 1 female thread  
 Mobile, raccord femelle 10 x 1



287605



Cast brass | Laiton fondu

**Description**

Internal Ø | Ø intérieur : 27mm  
 Height | Hauteur : 15mm  
 10 x 1 female thread | Femelle 10 x 1

287838



Cast brass | Laiton fondu

**Description**

Internal Ø | Ø intérieur : 17mm  
 Height | Hauteur : 31mm  
 13 x 1 female thread | Femelle 13 x 1





# Lampshade galleries 57mm

Griffes

288525



Brass | Laiton

**Description**

Hole | Trou : Ø11mm  
Height | Hauteur : 17mm

288636



Brass | Laiton

**Description**

Hole | Trou : Ø28mm  
Height | Hauteur : 15mm

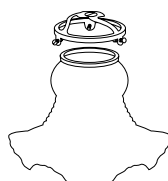

**Application**

Classic gallery for old tulip-shaped lampholder | Griffes classique pour abat-jour tulipe



# Lampshade galleries 57mm

Griffes

289203



Polished brass  
Laiton poli

289214



Polished lacquered brass  
Laiton poli verni

289325



Chrome-plated brass  
Laiton chromé

**Description**

Hole | Trou : Ø11mm  
Height | Hauteur : 29mm



# Lampshade gallerie 85mm

Griffe

288760



Polished lacquered brass  
Laiton poli verni

**Description**

Hole | Trou : Ø11mm  
Height | Hauteur : 29mm



# Lampshade gallerie 100mm

Griffe

288869



Polished lacquered brass  
Laiton poli verni

## Description

Hole | Trou : Ø11mm  
Height | Hauteur : 29mm



# Gallery nipple

Raccord hublot

289658



Chrome-plated brass  
Laiton chromé

## Description

Diameter | Diamètre : Ø85mm  
Height | Hauteur : 27mm  
10 x 1 Female thread | Femelle 10 x 1



# Piano wire springs

Ressorts corde de piano

290604



Length | Longueur : 80mm

290615



Length | Longueur : 90mm

290637



Length | Longueur : 110mm



## Description

Material | Matériau : Steel | Acier  
Hole | Trou : Ø10.5mm

# Threaded tubes

Tubes filetés

300014



Steel | Acier

## Description

French Paris thread | Pas français de Paris  
Length | Longueur : 1m  
Diameter | Diamètre : Ø16.85mm

300147



Zinc-plated steel | Acier zingué

## Description

French becs thread | Pas français becs  
Length | Longueur : 1m  
Diameter | Diamètre : Ø8mm

# Threaded tubes

Tubes filetés

300369



Brass | Laiton

300370



Zinc-plated steel | Acier zingué

## Description

International thread 10 x 1 | Pas international 10 x 1  
Length | Longueur : 1m  
Diameter | Diamètre : Ø10mm

# Threaded tubes

Tubes filetés

300382



Zinc-plated steel | Acier zingué

## Description

International thread 10 x 1 | Pas international 10 x 1  
Length | Longueur : 2m  
Diameter | Diamètre : Ø10mm

300481



Zinc-plated steel | Acier zingué

## Description

International thread 13 x 1 | Pas international 13 x 1  
Length | Longueur : 1m  
Diameter | Diamètre : Ø13mm

# Small threaded tube

Tubulure filetée

302195



Brass | Laiton

## Description

International thread 8 x 1 | Pas International 8 x 1  
Length | Longueur : 20mm  
Diameter | Diamètre : Ø8mm



# Small threaded tubes

Tubulures filetées

302598



Length | Longueur : 50mm

302554



Length | Longueur : 15mm

## Description

International thread 10 x 1 with flat | Pas international 10 x 1 avec méplat  
Diameter | Diamètre : Ø10mm  
Finish | Finition : Zinc-plated steel | Acier zingué



# Small threaded tubes

Tubulures filetées

302610



Length | Longueur : 20mm

302621



Length | Longueur : 30mm

302643



Length | Longueur : 50mm

## Description

International thread 13 x 1 | Pas International 13 x 1  
Diameter | Diamètre : Ø13mm  
Material | Matériau : Zinc-plated steel | Acier zingué



# Small threaded tubes

Tubulures filetées



Ref.	Length Longueur		Ref.	Length Longueur	
302257	10mm	100	302358	55mm	500
302268	12mm	100	302369	60mm	500
302279	15mm	100	302371	65mm	500
302281	20mm	100	302382	70mm	500
302292	25mm	100	302393	75mm	500
302303	30mm	100	302404	80mm	500
302314	35mm	100	302415	85mm	500
302325	40mm	100	302426	90mm	500
302336	45mm	100	302437	95mm	500
302347	50mm	100	302448	100mm	500
			302460	120mm	500
			302471	130mm	500
			302482	140mm	500
			302493	150mm	500
			302537	190mm	500
			302548	200mm	500
			302551	300mm	500

## Description

International thread 10 x 1 | Pas International 10 x 1  
Diameter | Diamètre : Ø10mm  
Material | Matériau : Zinc-plated steel | Acier zingué

# Smooth tube

Tube lisse

300825



## Description

Length | Longueur : 1m  
Internal diameter | Diamètre intérieur : Ø11mm  
External diameter | Diamètre extérieur : Ø12mm  
Material | Matériau : Brass | Laiton  
Covering tube | Tube de couverture

# 6 sided nuts

Ecrous 6 pans

303009



Ø16.85mm

Thickness | Épaisseur : 4mm SP21

**Description**

Material | Matériau : Turned brass | Laiton décolleté  
French thread nut Paris | Ecrou pas de Paris

303121



Ø10.85mm

Thickness | Épaisseur : 2mm SP14

**Description**

Material | Matériau : Turned brass | Laiton décolleté  
French thread nut becs | écrou pas des becs

303598



Thickness | Épaisseur : 2mm SP14

**Description**

Material | Matériau : Turned brass | Laiton décolleté  
International thread 10 x 1 | Pas international 10 x 1



303619



Thickness | épaisseur : 2.5mm SP14

**Description**

Material | Matériau : Zinc-plated steel | Acier zingué  
10 x 1 International thread | 10 x 1 Pas international

303620



Thickness | épaisseur : 4mm SP14

**Description**

Material | Matériau : Zinc-plated steel | Acier zingué  
10 x 1 International thread | 10 x 1 Pas international

303487



Thickness | épaisseur : 3.5mm SP18

**Description**

Material | Matériau : Zinc-plated stamped steel | Acier découpé zingué  
International thread 13 x 1 | Pas international 13 x 1

303700



Thickness | épaisseur : 3mm SP14

**Description**

Material | Matériau : Nylon  
International thread 10 x 1 | Pas international 10 x 1  
Color | Couleur : Black | Noir

331972



Thickness | épaisseur : 3mm SP7

**Description**

Material | Matériau : Brass | Laiton  
Thread 4 x 70 | Raccord 4 x 70  
For | Pour : 309765 & 331951

303675



Thickness | épaisseur : 4mm SP11

**Description**

Material | Matériau : Zinc-plated turned steel | Acier zingué décolleté  
International thread 8 x 1 | Pas international 8 x 1

## Threaded washers

Rondelles filetées

303731



Ø13mm

Thickness Épaisseur : 2.5mm

303842



Ø20mm

Thickness Épaisseur : 2mm



**Description**

Material | Matériau : Brass | Laiton  
Thread 10 x 1 | Raccord 10 x 1

# Knurled washer

Rondelle crantée

303953



Ø18mm

Thickness Épaisseur : 1.5mm



## Description

Material | Matériau : Zinc-plated steel | Acier zingué  
Thread 10 x 1 | Raccord 10 x 1

# Washers

Rondelles

304126



Ø24mm

Thickness Épaisseur : 1mm

304237



Ø18mm

Thickness Épaisseur : 1mm

304783



Ø17.3mm

Thickness Épaisseur : 1.5mm

304561



Ø40mm

Thickness Épaisseur : 1mm



## Description

Material | Matériau : Brass | Laiton  
Hole | Trou : Ø11mm

## Description

Material | Matériau : Brass | Laiton  
Hole | Trou : Ø11mm

## Description

Material | Matériau : Treated steel | Acier traité  
Hole | Trou : Ø10.5mm  
"Grower" washer | Rondelle "Grower"

## Description

Material | Matériau : Zinc-plated steel | Acier zingué  
Hole | Trou : Ø10.5mm

# PVC washers

Rondelles PVC

304905



Ø14mm

Hole | Trou : Ø10.2mm

304916



Ø22mm

Hole | Trou : Ø10.2mm

304927



Ø31mm

Hole | Trou : Ø10.2mm

304938



Ø51mm

Hole | Trou : Ø13.5mm



## Description

Colour | Couleur : Transparent  
Thickness | Épaisseur : 2mm  
Flexible | Souple

# Male 6 sided bushings with flange

Raccords mâle 6 pans à portée

305421

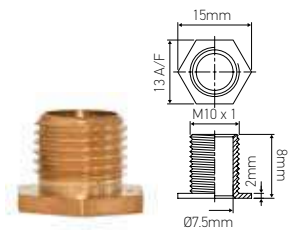

Height | Hauteur : 8mm

305467

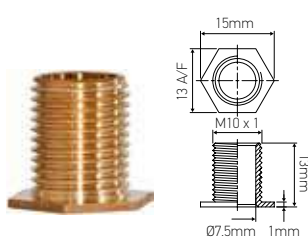

Height | Hauteur : 13mm

305454



Height | Hauteur : 13mm  
2 flat parts | 2 méplats



## Description

Material | Matériau : Brass | Laiton  
10 x 1 International thread | Pas International 10 x 1

# Male bushings with flange

Raccords mâle à portée

305478

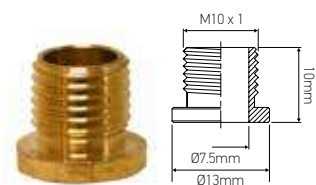

Height | Hauteur : 10mm

305590

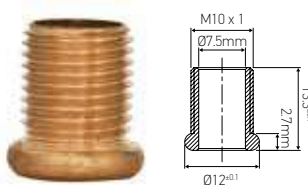

Height | Hauteur : 13mm



## Description

Material | Matériau : Brass | Laiton  
10 x 1 Male thread | Mâle 10 x 1  
International thread | Pas International

# Male bushings with flange

Raccords mâle à portée

305955



Double male thread 10 x 1 and Becs (10.85mm)  
Double raccord Mâle 10 x 1 avec Becs (10.85mm)

305944



Double male thread 10 x 1  
Double raccord Mâle 10 x 1



## Description

Material | Matériau : Brass | Laiton  
Dimensions (Ø x H) : Ø14 x 15mm  
Hole | trou : Ø6.5mm  
International thread | Pas International



# Double female couplings

Raccords double femelle

306340

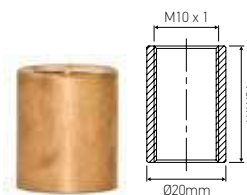

Brass | Laiton

306351

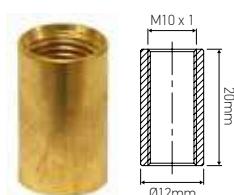

Brass | Laiton

306359



Chrome-plated brass  
Laiton chromé

306574

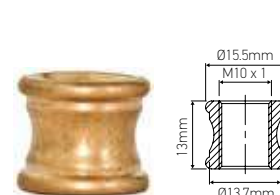

Brass | Laiton



## Description

Paris French thread 16.85mm | Pas de Paris 16.85mm

## Description

International thread 10 x 1 | Pas international 10 x 1

# Double female couplings

Raccords double femelle

306362



## Description

Dimensions : 14 x 15mm

Material | Matériau : Brass | Laiton

International thread 10 x 1 with locking screws

Pas international avec vis de blocage 10 x 1

306473



## Description

Dimensions : 16 x 20mm

Material | Matériau : Brass | Laiton

International thread 13 x 1 | Pas international 13 x 1



# Male & female bushing

Raccord mâle et femelle

306796

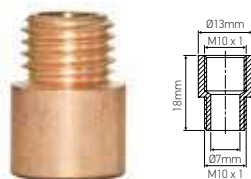

Chrome-plated brass | Laiton chromé

## Description

Material | Matériau : Brass | Laiton

International thread | Pas International

10 x 1 male & female bushing | Raccord mâle et femelle 10 x 1

Dimensions : 13 x 18mm



# Reduction nipples

Raccords de réduction

307002



Male thread bushing (10,85 x 1,33), female 10 x 1  
Raccord mâle becs (10,85 x 1,33), femelle 10 x 1

307013

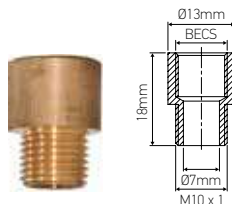

Female thread bushing (10,85 x 1,33), male 10 x 1  
Raccord femelle becs (10,85 x 1,33), mâle 10 x 1

307124

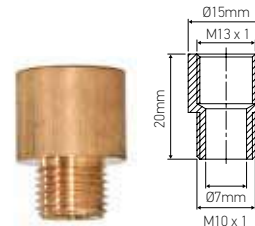

Female thread bushing 13 x 1, male 10 x 1  
Raccord femelle 13 x 1, mâle 10 x 1



25

## Description

Material | Matériau : Brass | Laiton

# Soldering bush

Raccords à souder

306929

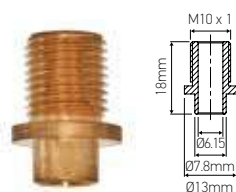

With 8mm flange | Avec enclavage 8mm

306930

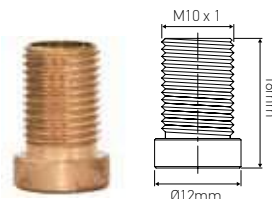

For tube with Ø8mm | Pour tube Ø8mm

306941

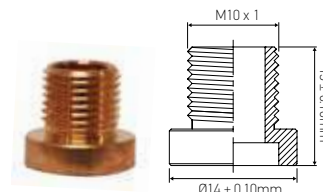

For tube with Ø10mm | Pour tube Ø10mm



25

## Description

Material | Matériau : Brass | Laiton  
10 x 1 Male bushing | Raccord mâle 10 x 1  
International thread | Pas International

# Hickeys

Raccords étrier

307902



Dimensions (Ø x H) : Ø13 x 10mm  
10 x 1 male and 8 x 1 female thread  
Mâle 10 x 1, femelle 8 x 1

307350



Dimensions (Ø x H) : Ø18 x 20mm  
10 x 1 female thread with locking screws | Raccord double femelle 10 x 1 avec vis d'arrêt

307346



Dimensions (Ø x H) : Ø14 x 20mm



500

## Description

Material | Matériau : Brass | Laiton  
International thread | Pas International

# Nipples on thin plate

Raccords à lame

308136



Hole | Trou : Ø4mm

308147



Hole | Trou : Ø10mm



## Description

Material | Matériau : Zinc-plated steel | Acier zingué

Spacing | Ecartement : 38mm

Length | Longueur : 54mm

Width | largeur : 17mm

10 x 1 male thread nipple | Raccord mâle 10 x 1

# Finials

Raccords fin de lustre

309610



Ø8mm

309721



Ø10mm

309732



Ø14mm



## Description

Material | Matériau : Brass | Laiton

Female thread 3 x 50 | Pas femelle 3 x 50

## Description

Material | Matériau : Brass | Laiton

Female thread 4 x 70 | Femelle 4 x 70

## Description

Material | Matériau : Brass | Laiton

Female thread 4 x 70 | Femelle 4 x 70

310127



Ø16mm



## Description

Material | Matériau : Brass | Laiton

Female thread 10 x 1 | Femelle 10 x 1

Height | Hauteur : 20mm

# Top & side threaded bushing

Raccord équerre

309007



309129



## Description

Material | Matériau : Brass | Laiton  
Ball with bearing, double female 10 x 1 | Boule à portée, double femelle 10 x 1  
Bottom Diameter | Diamètre à la base : Ø18mm

## Description

Material | Matériau : Brass | Laiton  
10 x 1 male and female thread | Mâle et femelle 10 x 1  
Length | Longueur : 31mm  
Height | Hauteur : 26mm

# Bushings on plate with 2 holes

Raccords à plaque 2 trous

308470



Brass | Laiton

308482



Chrome-plated brass | Laiton chromé



## Description

Spacing | Ecartement : 17mm  
Holes | Trous : Ø3mm  
Dimensions (Ø x H) : Ø25 x 7mm  
Male thread 10 x 1 | Mâle 10 x 1

308692



Brass | Laiton  
Male thread 10 x 1 | Mâle 10 x 1

308702



Chrome-plated brass | Laiton chromé  
Male thread 10 x 1 | Mâle 10 x 1

308713



Brass | Laiton  
Female thread 10 x 1 | Femelle 10 x 1



## Description

Spacing | Ecartement : 17mm  
Holes | Trous : Ø3mm  
Dimensions (Ø x H) : Ø40 x 7mm

# Ball with rod

Boule à tige

309765

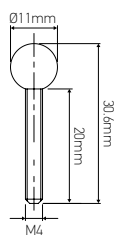

## Description

Material | Matériau : Brass | Laiton  
4 x 70 Female thread | Femelle filetage 4 x 70  
Dimensions (Ø x W) : Ø11 x 20mm

# Candle cup

Bobèche

320486

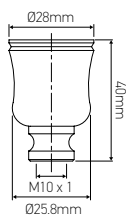

## Description

Material | Matériau : Brass | Laiton  
Dutch style | Style hollandais  
Female thread 10 x 1 | Femelle 10 x 1  
Dimensions (Ø x H) : Ø28 x 41mm

# Lampholder cover

Cache-douille

320596



## Description

Material | Matériau : Brass | Laiton  
Hole | Trou : Ø10.2mm  
Dimensions (Ø x H) : Ø42 x 35mm  
For E27 lampholder | Pour douille E27

# 1/2 Sphere lampholder cover

Cache-douille 1/2 sphère

320719



## Description

Material | Matériau : Polished and laquered brass | Laiton poli verni  
Dimensions (Ø x H) : Ø39 x 19mm

# Pan

Coupelle

321626



## Description

Material | Matériau : Brass | Laiton  
Hole | Trou : Ø11mm  
Diameter | Diamètre : Ø100mm

# Swivel Ø13mm

Rotule

337724

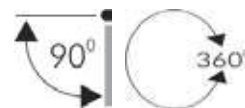

## Description

Material | Matériau : Chrome-plated brass | Laiton chromé  
90° articulated arm 8 x 1 male thread | Bras mâle 8 x 1 articulé 90°  
360° rotation with stop | Rotation 360° avec blocage  
Female thread 8 x 1 | Raccord femelle 8 x 1  
International thread | Pas International  
Dimensions (Ø x H) : Ø13 x 32mm  
Torsion | Force : 3kg

# Swivels Ø16mm

Rotules

337009



Brass | Laiton

337020



Chrome-plated brass | Laiton chromé



## Description

10 x 1 male and female thread | Mâle et femelle 10 x 1  
360° rotation with stop | Rotation 360° avec blocage  
International thread | Pas International  
Diameter | Diamètre : Ø16mm  
Torsion | Force : 6kg

# Swivels Ø16mm

Rotules

337010



Chrome plated brass | Laiton chromé

337034



Brass | Laiton



## Description

10 x 1 female nipple with locking screw | Raccord femelle 10 x 1 avec vis d'arrêt  
90° articulated arm 10 x 1 male thread | Bras mâle 10 x 1 articulé 90°  
360° rotation with stop | Rotation 360° avec blocage  
International thread | Pas International  
Dimensions (Ø x W) : Ø16 x 39mm  
Torsion | Force : 5kg

# Swivels Ø19mm

Rotules

336785



Brass | Laiton  
Male and female thread | Mâle et femelle 10 x 1

336907



Chrome plated brass | Laiton chromé  
Double female thread | Double femelle 10 x 1

336674



Brass | Laiton  
Male and female thread | Mâle et femelle 10 x 1



## Description

Diameter | Diamètre : Ø19mm  
Swivel adjustable with key | Rotule réglable par clé  
International thread | Pas International

# Swivel Ø20mm

Rotule

337132



Chrome plated brass | Laiton chromé

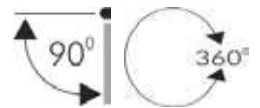

## Description

Dimensions (Ø x H) : Ø20 x 48mm  
10 x 1 female nipple with locking screw | Raccord femelle 10 x 1 avec vis d'arrêt  
90° articulated arm 10 x 1 male thread | Bras mâle 10 x 1 articulé 90°  
360° rotation with stop | Rotation 360° avec blocage  
International thread | Pas International  
Torsion | Force : 14kg

# Swivel Ø10mm

Rotule

337641



Brass | Laiton



## Description

Dimensions (Ø x H) : Ø10 x 29mm  
Material | Matériau : Brass | Laiton  
8 x 1 female thread | Raccord femelle 8 x 1  
90° articulated arm 8 x 1 male thread | Bras mâle 8 x 1 articulé 90°  
Torsion | Force : 1-2kg



# Plier

Pince

336501

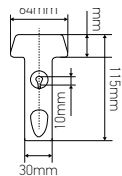

Black | Noir

**Description**

Material | Matériau : Nylon

Delivered non-assembled | Livrée démontée

# Pipes

Chandelles

309420

309431

309442

309453

309464

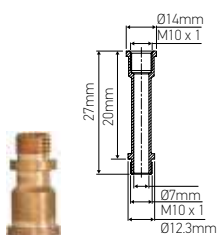

Length | Longueur : 20mm

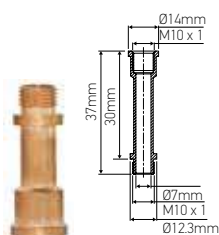

Length | Longueur : 30mm

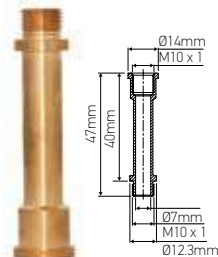

Length | Longueur : 40mm

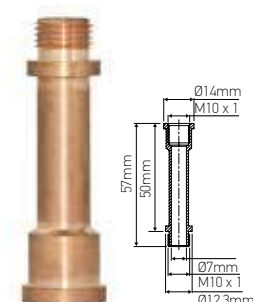

Length | Longueur : 50mm

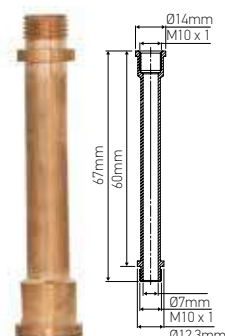

Length | Longueur : 60mm

**Description**

Material | Matériau : Turned brass | Laiton décolleté

10 x 1 Male and female thread | Mâle et femelle 10 x 1

Bottom Diameter | Diamètre à la base : Ø14mm

# Pipes

Chandelles

309475



Length | Longueur : 70mm

309486



Length | Longueur : 80mm

309497



Length | Longueur : 100mm

309509



Length | Longueur : 120mm



## Description

Material | Matériau : Turned brass | Laiton décolleté  
 10 x 1 Male and female thread | Mâle et femelle 10 x 1  
 Bottom diameter | Diamètre à la base : Ø14mm

# Pipes

Chandelles

310012

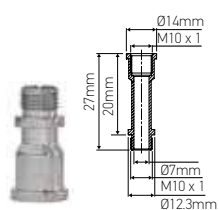

Length | Longueur : 20mm

310034

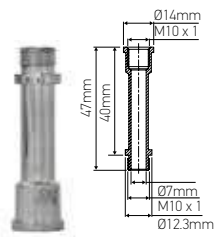

Length | Longueur : 40mm

310078

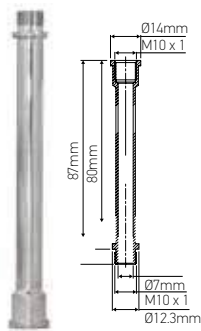

Length | Longueur : 80mm

310089

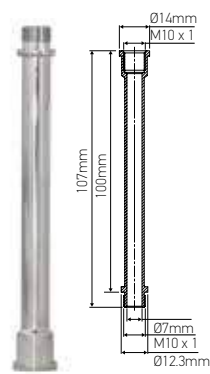

Length | Longueur : 100mm



## Description

Material | Matériau : Chrome-plated brass | Laiton chromé  
 10 x 1 Male and female thread | Mâle et femelle 10 x 1  
 Bottom Diameter | Diamètre à la base : Ø14mm

# Extension tubes

Tubes rallonge

330573



Polished & lacquered brass | Laiton poli verni  
Ø12.1 x 40mm

330215



Chrome-plated brass | Laiton chromé  
Ø12.1 x 40mm

330237



Chrome-plated brass | Laiton chromé  
Ø12.1 x 80mm



## Description

10 x 1 male and female thread | Mâle et femelle 10 x 1

# Extension tubes

Tubes rallonge

330359



Polished & lacquered brass | Laiton poli verni  
Ø9.1 x 250mm

330697



Polished & lacquered brass | Laiton poli verni  
Ø9.1 x 300mm



## Description

10 x 1 male and female thread | Mâle et femelle 10 x 1

# Adaptator

Talon

342020

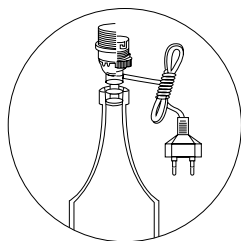

White | Blanc

## Description

Material | Matériau : Polyethylene | Polyéthylène  
 With 3 suction-grip discs | Avec 3 disques ventouse  
 10 x 1 Male thread | Mâle 10 x 1

# Extensible adaptors (Fittings for bottles)

Talons extensibles (Equipements de bouteille)

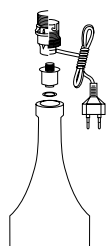
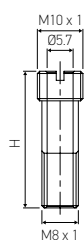

- 342142 Fitting 12 - 13mm
- 342164 Fitting 14 - 15mm
- 342186 Fitting 16 - 18mm
- 342208 Fitting 19 - 21mm
- 342230 Fitting 22 - 24mm
- 342252 Fitting 25 - 28mm
- 342274 Fitting 29 - 32mm
- 342296 Fitting 33 - 36mm

## Description

10 x 1 Male thread | Mâle 10 x 1  
 Color | Couleur : Gold | Or  
 Fitting | Raccord

# Sliding pipe

Tube coulissant

330719



Polished lacquered brass | Laiton poli verni

## Description

10 x 1 Male thread | Mâle 10 x 1

Fixed part Ø10mm, sliding part Ø8mm | Partie fixe Ø10mm, partie coulissant Ø8mm

Sliding from 180 to 300mm | Coulissant de 180 à 300mm

# Sliding pipe

Tube coulissant

330932



Polished lacquered brass | Laiton poli verni

## Description

Male threads | Raccords mâles

Fixed part | Partie fixe : 13 x 1

Washers Ø | Ø des rondelles : 25mm

Locking nut | Écrou de serrage

Sliding part | Partie coulissante : 10 x 1, H. 190mm with anti-rotation screw | avec vis anti-rotation

# Bushing

Embase

331840



## Description

Material | Matériau : Brass | Laiton

Male thread 10 x 1, female thread 4 x 70 | Mâle 10 x 1, femelle 4 x 70

# Acorn

Gland

331728



## Description

Material | Matériau : Brass | Laiton

Without bushing, 4 x 70 female thread | Sans embase, femelle 4 x 70

# Turned nipple

Filet décolleté

331951



## Description

Material | Matériau : Brass | Laiton

Length | Longueur : 15mm

Cutted nipple 4 x 70 | Filet décolleté 4 x 70

Use with ref | Utiliser avec la ref : 331728

# Cluster bodies

Boîtes nourrice

335715



Ø40mm

Hole | Trou : Ø8.2mm

With 2 nipples 10 x 1 male thread

Avec 2 raccords mâle 10 x 1

335726



Ø40mm

Hole | Trou : Ø8.2mm

With 3 nipples 10 x 1 male thread

Avec 3 raccords mâle 10 x 1

335837



Ø27mm

Hole | Trou : Ø26.1mm

With 2 nipples 10 x 1 male thread

Avec 2 raccords mâle 10 x 1



## Description

Material | Matériau : Brass | Laiton

Female thread 10 x 1 | Femelle 10 x 1

# Adaptors

Pneus

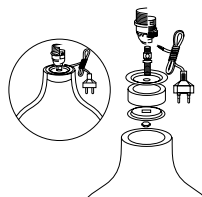
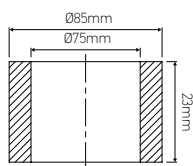

- 340017 Rubber Diameter Ø35mm
- 340039 Rubber Diameter Ø40mm
- 340051 Rubber Diameter Ø45mm
- 340073 Rubber Diameter Ø50mm
- 340095 Rubber Diameter Ø55mm
- 340137 Rubber Diameter Ø60mm
- 340159 Rubber Diameter Ø65mm
- 340171 Rubber Diameter Ø70mm
- 340193 Rubber Diameter Ø75mm
- 340215 Rubber Diameter Ø80mm
- 340237 Rubber Diameter Ø85mm

**Description**

Extensible rubber, 10 x 1 Male thread with cable passage  
 Caoutchouc extensible, Mâle 10 x 1 avec raccord passage de câble

# Bi-plates

Bilames

341012



Spacing | Ecartement : 80mm

341034



Spacing | Ecartement : 110mm

341056



Spacing | Ecartement : 150mm



**Description**

10 x 1 threaded nipple | Fileté 10 x 1  
 With articulated plates | Avec lames articulées  
 Side hole for wire | Trou latéral pour fil

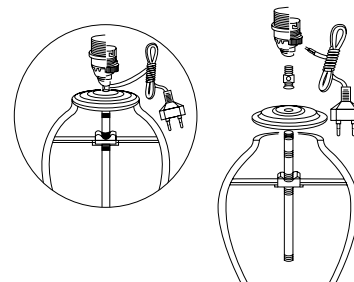

Application example | Exemple d'utilisation

# Coupling with side hole for wire

Raccord passage de câble

341190



Brass | Laiton

142529



Chrome-plated | Chromé

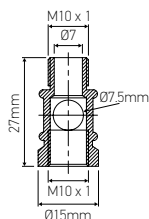

## Description

Material | Matériau : Brass | Laiton

Height | Hauteur : 20mm

10 x 1 male and female thread | Mâle et femelle 10 x 1

# Rigid plates

Lames rigides

341212



Spacing | Ecartement : 80mm

341234

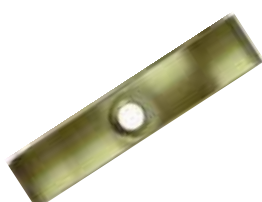

Spacing | Ecartement : 110mm

341256



Spacing | Ecartement : 150mm



## Description

Material | Matériau : Brass-plated steel | Acier Laitonné

10 x 1 Female thread | Femelle 10 x 1

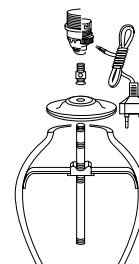

Application example | Exemple d'utilisation



# Curved cover

Dessus galbé

346914

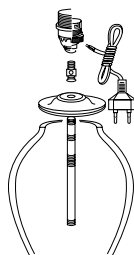

Application example | Exemple d'utilisation

## Description

Material | Matériau : Brushed brass | Laiton toilé

Hole | Trou : Ø11mm

Diameter | Diamètre : Ø70mm

# Stepped covers

Dessus à étapes



346425 Ø25mm	346524 Ø70mm
346436 Ø30mm	346546 Ø80mm
346447 Ø35mm	346568 Ø90mm
346458 Ø40mm	346580 Ø100mm
346469 Ø45mm	346591 Ø105mm
346470 Ø50mm	346602 Ø110mm
346481 Ø55mm	346613 Ø115mm
346492 Ø60mm	346635 Ø125mm
346513 Ø65mm	346657 Ø135mm

## Description

Material | Matériau : Brushed brass | Laiton toilé

Hole | Trou : Ø11mm

Thickness | Épaisseur : 0.5mm





# Tearing cable clamps

Maintiens de câbles

230123



White | Blanc

## Description

Thickness | Épaisseur : 2mm  
Material | Matériau : Nylon  
For connector block | Pour barrette

230133



White | Blanc

## Description

Thickness | Épaisseur : 2mm  
Material | Matériau : Nylon  
For cables | Pour câbles : H03VV-F, H05VV-F

230141



Black | Noir

230313



White | Blanc

## Description

Thickness | Épaisseur : 2mm  
Material | Matériau : Nylon  
For cables | Pour câbles : H03VV-F

T 90°C



230323



White | Blanc

## Description

Thickness | Épaisseur : 2mm  
Material | Matériau : Nylon  
For cables | Pour câbles : H03VVH-2F

230349



Transparent

## Description

Thickness | Épaisseur : 2mm  
Material | Matériau : Nylon  
For cables | Pour câbles : H03VV-F

T 110°C



# Cable clamps with locking screw

Maintiens de câbles avec vis de blocage

230453



White | Blanc

## Description

Material | Matériau : Nylon  
Exterior | Extérieure : Ø10.5mm  
Interior | Intérieure : Ø6.5mm

230461



Black | Noir

230573



White | Blanc

## Description

Material | Matériau : Nylon  
Exterior | Extérieure : Ø12mm  
Interior | Intérieure : Ø7.4mm

230591



Black | Noir



# Cable grips with locking screw

Serre-câbles avec vis de blocage

230603

230611

230613

230619

T 110°C

100/1000



White | Blanc

Black | Noir



White | Blanc



Transparent

## Description

Material | Matériau : Nylon  
Female thread 10 x 1 | Femelle 10 x 1  
Diameter | Diamètre : Ø7mm

## Description

Material | Matériau : Nylon  
Female thread 10 x 1 | Femelle 10 x 1  
Interior | Intérieure : Ø6,5mm

## Description

Material | Matériau : Polycarbonate  
Female thread 10 x 1 | Femelle 10 x 1

230723

230731

T 90°C

100/1000

230983

T 100°C



White | Blanc



Black | Noir

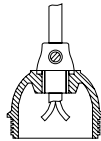

White | Blanc

## Description

Material | Matériau : Nylon  
Tapered cable clamp, male thread 10 x 1 | Raccord conique, mâle 10 x 1  
Exterior | Extérieure : Ø13mm  
Interior | Intérieure : Ø8,4mm

## Description

Material | Matériau : Nylon  
Male thread 10 x 1 | Raccord mâle 10 x 1

230843

230851

230991

T 110°C

100/1000



White | Blanc



Black | Noir

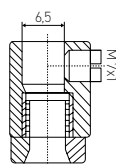

Black | Noir

## Description

Material | Matériau : Nylon  
Female nipple and 6 sided male thread, 10 x 1 male and female threads  
Raccord femelle et raccord 6 pans, raccords mâle et femelle 10 x 1

## Description

Material | Matériau : Nylon  
Male thread 10 x 1 | Mâle 10 x 1

# Cable grips

Serre-câbles

231029



Transparent

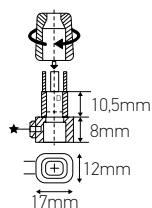

231139



Transparent

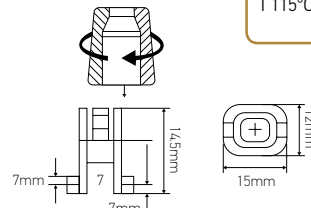

T 115°C

100/1000

## Description

Material | Matériau : Polycarbonate

Female bushing , thread length 10.5mm | Raccord femelle, longueur filetage 10.5mm

## Description

Material | Matériau : Polycarbonate

For lampholder, smooth base hole 10mm | Pour douille, culot trou lisse 10mm

# Capucin for cable grip

Capuchon pour serre-câble

231159



Transparent

100/1000

## Description

Material | Matériau : Polycarbonate

Female bushing capucin 10 x 1 | Capuchon femelle 10 x 1

Dimensions (Ø x H) : Ø14.8 x 18.5mm

# Cord grips

Serre-câbles

231003



White | Blanc

231011



Black | Noir

T 85°C

## Description

Material | Matériau : Nylon

International male thread 10 x 1 | Raccord mâle pas international 10 x 1

Cables to be used | Câbles à utiliser : Round

# 6 sided bushes

Raccords 6 pans

232391



Black | Noir

232393



White | Blanc

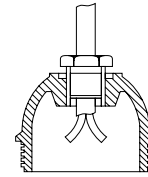
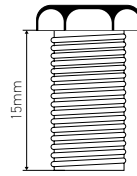

Application example | Exemple d'utilisation



## Description

Material | Matériau : Nylon

Thread length | Longueur filetage : 15mm

International Thread | Pas International : 10 x 1

# Connection tubes

Tubes de raccordement

231614



For E14 lampholder | Pour douille E14

231627



For E27 lampholder | Pour douille E27

T 85°C



## Description

With clamps and rotation | Avec arrêt de traction et de rotation

Material | Matériau : White polyacetal | Polyacétal blanc

Cables to be used | Câbles à utiliser : H03VVH-2F

# Insulation tube

Tubes d'isolement

231507



White | Blanc

For E27 lampholder | Pour douille E27

T 100°C

## Description

Material | Matériau : Nylon

Tube, insulator tip | Tube, embout isolant

For cables | Pour câbles : H03VVH-2F

# Locking clamp

Arrêts de traction et de rotation

231747

T 85°C

1000



Insert cable in the ISOLATOP jaw  
Introduire le câble dans la mâchoire de l'ISOLATOP

White | Blanc  
For E27 lampholder | Pour douille E27

## Description

Material | Matériau : White polyacetal | Polyacétal blanc  
Side exit | Sortie latérale  
Cables to be used | Câbles à utiliser : H03VVH-2F

# Earth terminals for lampholders

Bornes de mise à la terre pour douilles

231889

231902

231905

100/1000



## Description

Length | Longueur : 35mm  
Hole | Trou : Ø10.5mm

## Description

Length | Longueur : 22mm  
Width | largeur : 8mm  
Hole | Trou : Ø4.2mm  
Thickness | Épaisseur : 0.9mm

## Description

Length | Longueur : 30mm  
Width | largeur : 15mm  
Hole | Trou : Ø10.5mm  
Thickness | Épaisseur : 0.9mm

# Pression nipple for wooden lamp base

Raccord pour pied de lampe en bois

232561

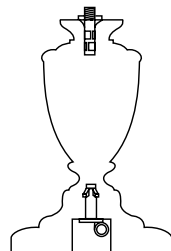

Brown | Marron

100/1000

## Description

Material | Matériau : Polyamide  
Male thread 10 x 1 | Raccord mâle 10 x 1  
Diameter | Diamètre : Ø10mm



# Insulation grommets

Embouts d'isolation

232604



Transparent

## Description

For tube | Pour tube :  $\varnothing 7\text{mm}$   
Cable passage | Passage conducteurs :  $\varnothing 5.5\text{mm}$

232619



Transparent

## Description

For tube | Pour tube :  $\varnothing 13\text{mm}$   
Cable passage | Passage conducteurs :  $\varnothing 7.5\text{mm}$

232609



Transparent

## Description

For tube | Pour tube :  $\varnothing 10\text{mm}$   
Cable passage | Passage conducteurs :  $\varnothing 5.9\text{mm}$

232617



Gold | Or



232612



Transparent



## Description

Finish | Finition : Polyethylene | Polyéthylène  
For tube | Pour tube :  $\varnothing 11\text{mm}$   
Cable passage | Passage conducteurs :  $\varnothing 6\text{mm}$

# Grommets

Passe-fils

232763



White | Blanc

232771



Black | Noir

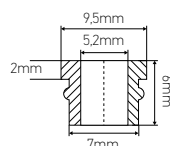

232793



White | Blanc

232791



Black | Noir

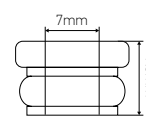

## Description

Finish | Finition : Polyethylene | Polyéthylène  
For tube | Pour tube :  $\varnothing 8\text{mm}$   
Cable passage | Passage conducteurs :  $\varnothing 5\text{mm}$

## Description

Finish | Finition : Polyethylene | Polyéthylène  
For tube | Pour tube :  $\varnothing 10\text{mm}$   
Cable passage | Passage conducteurs :  $\varnothing 7\text{mm}$

# Grommets

Passe-fils

232803



White | Blanc

232821



Black | Noir

232837



Gold | Or

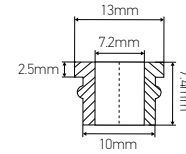

## Description

Finish | Finition : Polyethylene | Polyéthylène

For tube | Pour tube : Ø10mm

Cable passage | Passage conducteurs : Ø7.2mm

232911



Black | Noir

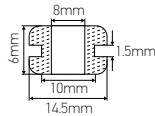

232901



Black | Noir  
Waterproof | étanche

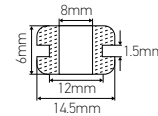

## Description

Material | Matériau : PVC

For tube | Pour tube : Ø10mm

Cable passage | Passage conducteurs : Ø8mm

## Description

Material | Matériau : PVC

For tube | Pour tube : Ø12mm

Cable passage | Passage conducteur : Ø6mm max

# Cable clamps

Arrêts de traction

232953



White | Blanc

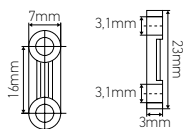

232963



White | Blanc



## Description

Material | Matériau : Nylon

For tube | Pour tube : Ø3.1mm

## Description

Material | Matériau : Nylon

For tube | Pour tube : Ø4.2mm

# Adaptor rings E27 / E14 - B22

Bagues de réduction

233353



White | Blanc

233367



Gold | Or



## Description

Material | Matériau : Nylon

Diameter | Diamètre : Ø44mm

# Two-lamp housing

Boîtier bilampe

232584



White | Blanc

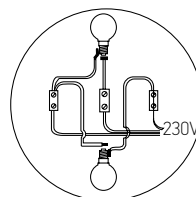
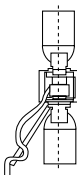
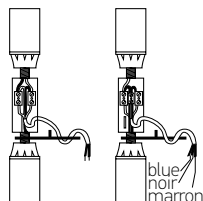

EN 60598

## Description

Material | Matériau : Thermoplastic | Thermoplastique

For 2 lampholders E14 or E27 | Pour deux douilles E14 ou E27

Cable to be used | Câble à utiliser : H03VVH-2F

Double male thread 10 x 1 | Raccord double mâle 10 x 1

Closure by clipping | Fermeture par clipsage

Lampholder not included | Douille non comprise

# Connectors

Connecteurs

233469



Transparent

Cable size | Section : 2.5mm - 380V

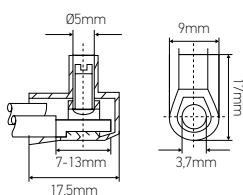

233479



Transparent

Cable size | Section : 6mm - 380V

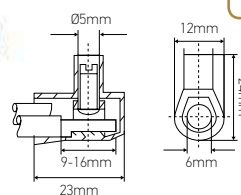

T 90°C



## Description

Finish | Finition : Polycarbonate

Plots | Pôles : 10

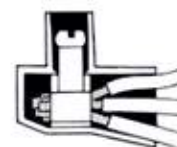

# Connector block for class I

Borne de connexion pour classe I

233481



Grey | Gris

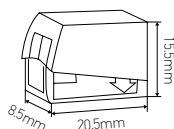

EN 60598

## Description

Cable stripping | Dénudage du câble : 9-11mm

Operating temperature 105°C, Peak Temperature 170°C | Temperature 105°C en continu, 170°C en pointe

For 0.5 - 2.5mm<sup>2</sup> cables | Pour 0.5 - 2.5mm<sup>2</sup> câbles

# Double connector block for class I

Borne de connexion double pour classe I

233492



Grey | Gris

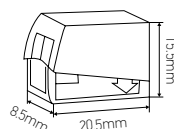

EN 60598

## Description

Cable stripping | Dénudage du câble : 9-11mm

Operating temperature 105°C, Peak Temperature 170°C | Temperature 105°C en continu, 170°C en pointe

For 0.5 - 2.5mm<sup>2</sup> cables | Pour 0.5 - 2.5mm<sup>2</sup> câbles

# Splicing connectors

Bornes pour boîte de dérivation

233502



Transparent  
Plots | Pôles : 2  
13.1 x 8.3 x 18.6mm

233503



Transparent  
Plots | Pôles : 3  
18.7 x 8.3 x 18.6mm

233505



Transparent  
Plots | Pôles : 5  
29.9 x 8.3 x 18.6mm



EN 60998

## Description

With operating levers | Avec leviers de commande  
Max. ambient operating T 85 °C | Température ambiante max T 85°C  
For 0.2 to 4mm<sup>2</sup> cables | Pour câbles 0.2 to 4mm<sup>2</sup>



# Connector blocks 222 series

Bornes de connexion série 222

233519



Grey | Gris  
Poles | Pôles : 3  
Wires | Fils : 3

233508



Grey | Gris  
Poles | Pôles : 5  
Wires | Fils : 5

## Description

Stripping 9-10mm  
3 x 0,08 – 4mm<sup>2</sup> "s" (2,5mm<sup>2</sup> "r" + "sr")  
400 V/4kV IN 32 A

## Description

Stripping 9-10mm  
5 x 0,08 – 4mm<sup>2</sup> "s" (2,5mm<sup>2</sup> "r" + "sr")  
400 V/4kV IN 32 A

# Set of plug-in connector blocks

Jeux de borniers embrochables à collerette de centrage

233538



Black | Noir  
Plots | Pôles : 2

233542



Black | Noir  
Plots | Pôles : 3

16A  
380V

1/100

## Description

Finish | Finition : Polyamide

Conductor Section & stripping | Section conducteur et dénudage : 0,5 - 4mm<sup>2</sup> & 7mm

Operating temperature 100°C, Peak Temperature 160°C | Température 100°C en continu, 160°C en pointe

For fuse | Pour fusible : 5 x 20mm

Tracking resistance PTI600 | Résistance au cheminement PTI600

Plug-in male and female connector with protection tongue | Connecteur mâles et femelles avec languette de protection  
Upto 2.5mm<sup>2</sup> | Jusqu'à 2,5mm<sup>2</sup>

## Connector blocks

Barrettes de connexion

233610



White | Blanc  
Plots | Pôles : 2

233611



White | Blanc  
Plots | Pôles : 3

233613



White | Blanc  
Plots | Pôles : 12

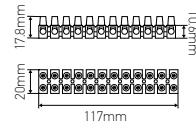
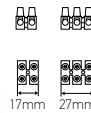

380V

T 110°C

25/300

## Description

Material | Matériau : Nylon

Cross-section | Section : 1.5 - 4mm<sup>2</sup>

# Connector blocks

Barrettes de connexion

233615



Black | Noir  
Plots | Pôles : 2

233629



Black | Noir  
Plots | Pôles : 12

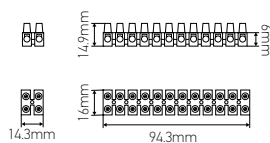

380V

T 110°C

50/500

## Description

Finish | Finition : Polyamide

Cross-section | Section : 1 x 0.75mm<sup>2</sup> + 1 x 1.5mm<sup>2</sup>

# Connector blocks for class II

Boîtiers de connexion pour classe II

233709



White | Blanc  
For oval cables H03VV-F

233705



White | Blanc  
For oval cables H03VVH-2F

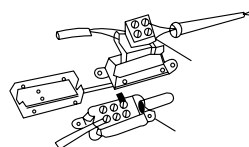

T 105°C

Glow wire  
850°



250

EN 60598

## Description

Material | Matériau : Thermoplastic | Thermoplastique

Removable blocks | Bornier amovible

With sleeve | Avec manchon

To be connected with network cables | Pour raccordement à l'installation

Length | Longueur : 80mm

Closure by clipping | Fermeture par clipsage

Dimensions : 42 x 19 x 11.5mm

# Connector block for class II

Boîtier de connexion pour classe II

233717



White | Blanc

Glow wire  
850°

T 105°C



## Description

Material | Matériau : Thermoplastic | Thermoplastique

For oval cables | Pour câbles ovales

Thermoplastic insulation | Isolant thermoplastique

Removable box | Bornier amovible

Without sleeve | Sans manchon

Clamp devices, closure by clipping | Dispositifs d'arrêt de traction fermeture par clipsage

Dimensions : 46 x 19,5 x 11mm

# Connector block

Boîtier de connexion

233728



White | Blanc

Glow wire  
850°

T 105°C



EN 60598

## Description

Material | Matériau : Thermoplastic | Thermoplastique

For round cable | Pour câble rond : H03VV - F3 x 0,5mm<sup>2</sup> / 3 x 0,75mm<sup>2</sup>

Thermoplastic connector box | Isolant thermoplastique

Fitted with removable 3-pole terminal block | Bornier amovible 3 pôles

Closure by clipping | Fermeture par clipsage

Dimensions : 46 x 27,5 x 11,5mm



# Connector block

Boîtier de connexion

233753

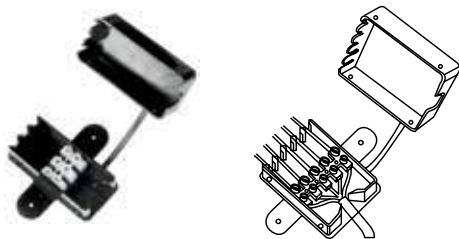

Glow wire  
850°

T 120°C

250

## Description

Material | Matériau : Thermoplastic | Thermoplastique

With 3 pole connector blocks 2,5 maximum | Avec blocs de connecteurs 3 pôles 2,5 maximum

Thermoplastic insulation box | Boîte isolante thermoplastique

Closure by clipping | Fermeture par clipsage

Single side outlet : cable H05VVF 3,4 or 5 conductors | Sortie latérale simple : câble H05VVF 3,4 ou 5 conducteurs

Multiple side outlet | Sortie multiple : cable H05VVH-2 or H03VVH-2F (2 x 0,5mm<sup>2</sup> ou 2 x 0,75mm<sup>2</sup>)

Dimensions : 74 x 35,5 x 21,5mm

# Connector block

Boîtier de connexion

233686

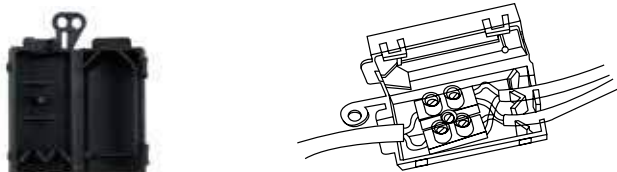

Black | Noir

Glow wire  
850°

T 105°C

250

## Description

Material | Matériau : Thermoplastic | Thermoplastique

For 2-phase connector blocks (REF. 233610) | Pour barrette 2 plots (REF. 233610)

Thermoplastic insulation box | Boîte isolante thermoplastique

For internal connection | Pour connection interne

Clamp devices | Dispositifs d'arrêt de traction

Closure by clipping | Fermeture par clipsage

Single side outlet | Côté sortie unique : cable H03VVH-2F Or H05VVH - 2F (2 x 0,5mm<sup>2</sup> / 2 x 0,75mm<sup>2</sup>) | câble H03VVH-2F / H05VVH - 2F (2 x 0,5mm<sup>2</sup> ou 2 x 0,75mm<sup>2</sup>)

Multiple side outlet | Sortie multiple : 1 - 4 cables of same type 2 x 0,5mm<sup>2</sup> | 1 à 4 câbles de même Type 2 x 0,5

Dimensions : 54 x 28 x 30mm

# Connector block

Boîtier de connexion

233731

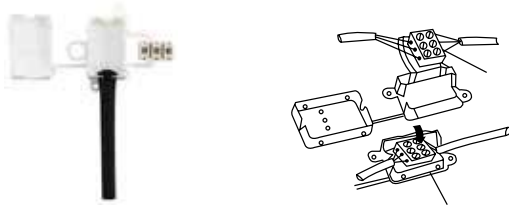

White | Blanc

Glow wire  
850°

T 105°C

250

EN 60598

## Description

Material | Matériau : Thermoplastic | Thermoplastique

Cable to be used | Câble à utiliser : 2 x 0.75mm<sup>2</sup> + 3 x 0.75mm<sup>2</sup>

With cable clamps | Avec serre-câbles

Wiring through central mounting fixture or through the 3 lateral V-type outlets | Distribution par fixation centrale ou par 3 sorties latérales à pinces

Closure by clipping | Fermeture par clipsage

Dimensions : 42.5 x 27.5 x 11.5mm

# Connector block

Boîtier de connexion

233742



White | Blanc

Glow wire  
850°

T 105°C



250

EN 60598

## Description

Material | Matériau : Thermoplastic | Thermoplastique

Thermoplastic insulation | Isolant thermoplastique

Bipolar connection | Connexion bipolaire

Thickness | Épaisseur : 13mm

Diameter | Diamètre : Ø50mm

Power supply by double insulation cable 2 x 0.75 or 3 x 0.75mm<sup>2</sup> with cable clamp

Alimentation par câble double isolation 2 x 0,75 / 3 x 0,75mm<sup>2</sup> avec serre-câble

Wiring through central mounting fixture or through the 3 lateral V-type outlets

Distribution par fixation centrale ou par 3 sorties latérales à pinces

Central and inner mounting | Fixation interne et centrale

Snap-on cover | Couvercle clipsable

# Pre-insulated terminal ends with insulation sleeve

Raccords embouts pré-isolés

233806

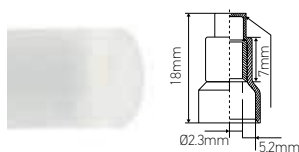

Transparent  
Ø2.3mm



1250

233816

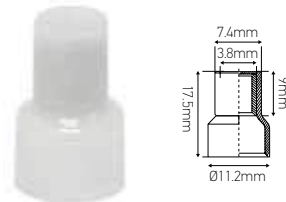

Transparent  
Ø3.8mm



600

## Description

Material | Matériau : Nylon

Tinned electrolytic copper fitting CU, Nylon blue insulation | Raccord cuivre électrolytique étamé cu - Isolant Nylon bleu

# Pre-insulated cable lug

Cosse à sertir pré-isolée

233836

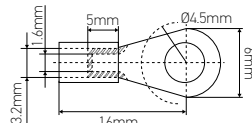

Red | Rouge



## Description

Ring-type cable lug, Insulation sleeve | Cosse à oeillet, Manchon isolant

Material | Matériau : PVC

Diameter | Diamètre : Ø1.6mm

# Butt and parallel connector

Connecteur en série

233856

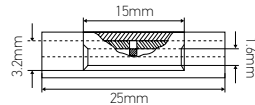

Red | Rouge



## Description

Material | Matériau : PVC

Connector, tinned electrolytic copper Cu | Connecteur, cuivre électrolytique étamé Cu

Diameter | Diamètre : Ø1.6mm

# 1 - 3 poles terminal blocks

Dominos 1 - 3 bornes

260118

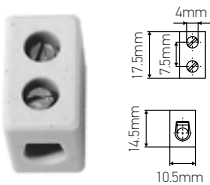

White | Blanc  
Plot | Pôle : 1

260120

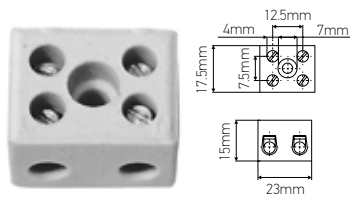

White | Blanc  
Plots | Pôles : 2

260132

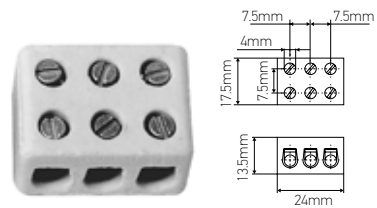

White | Blanc  
Plots | Pôles : 3



## Description

With steatine insulating body | Avec corps isolant steatine

Connecting capacity : 2.5mm<sup>2</sup> cross section cables | Capacité de connexion : 2.5mm<sup>2</sup> de câble de section

# Tiltable recessed fittings

Enjoliveurs orientables

380502



White | Blanc

380503



Satin Nickel | Nickel Satiné



## Description

Material | Matière : Cast aluminum | Fonte d'aluminium

Bulb not included | Ampoule non comprise

Diameter | Diamètre : Ø81 ⌀ 73mm

# Tiltable recessed fittings

Enjoliveurs orientables

380400



White | Blanc

380401



Satin Nickel | Nickel Satiné



## Description

Material | Matière : Stamped metal | Métal embouti

Bulb not included | Ampoule non comprise

Diameter | Diamètre : Ø90 ⌀ 68mm

# Non-tiltable recessed fittings

Enjoliveurs non-orientables

380500



White | Blanc

380501



Satin Nickel | Nickel Satiné



## Description

Material | Matière : Cast aluminum | Fonte d'aluminium

Bulb not included | Ampoule non comprise

Diameter | Diamètre : Ø77 ⌀ 60mm

# Non-tiltable recessed fittings

Enjoliveurs non orientables

380357



White | Blanc

380358



Satin Nickel | Nickel Satiné



## Description

Material | Matière : Stamped metal | Métal embouti

Bulb not included | Ampoule non comprise

Diameter | Diamètre : Ø80 ⌀ 70mm

# Spotisol with ring

Spotisol avec bague

167438



White | Blanc



NF C15-100  
EN 60 598

## Description

Usable from -20° C to + 110°C continuously | Utilisable de -20°C à + 110°C en continu

Maximum power : 50W with roll insulation / 35W with blown insulation | Puissance maximale : 50W avec isolant en rouleau / 35W avec isolant soufflé

Fire resistance self-extinguishing UL 94 V2 | Résistance au feu autoextinguible UL 94 V2

Height | Hauteur : 105mm

# Rectangular reflector for ceramic R7S lampholder

Réflecteur rectangulaire pour douille céramique R7S

260266



Aluminium coated quartz  
Quartz revêtu d'aluminium

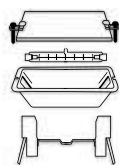

## Description

Narrow beam | Faisceau étroit : 160 x 70 x 28mm

For mounting with lampholder ref. 260027 | Pour montage avec douille ref. 260027

Dimensions : 160 x 70 x 28mm

# Steel clamp for protection device

Pince de fixation pour dispositif de protection

260321



Chrome-plated | Chromé

# Half-cylinder borosilicate glass for protection device

Demi-cylindre de verre borro-silicate pour dispositif de protection

260375

T 280°C



Transparent

## Description

Thickness | Epaisseur : 3.2mm

Width | Largeur : 40mm

Length | Longueur : 128mm

# Mounting screw with nut

Vis de fixation avec écrou

260332

50



Chrome-plated steel | Acier chromé

## Description

Use with ref. 260321 | À utiliser avec la ref. 260321









# Shade adaptors for E27 lampholders

Griffes de suspensions

289204

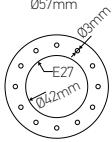

289205

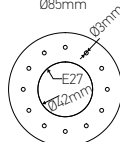
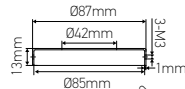

289206

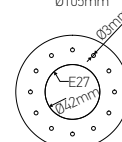
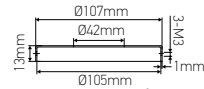

## Description

Material | Matériau : Steel | Acier  
Colour | Couleur : Black | Noir

# Glass lampshades for E27 lampholders

Verreries

187590



Clear | Clair

187591



Amber | Ambré

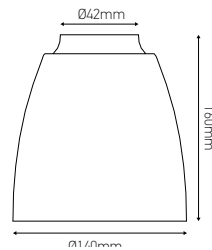

## Description

Material | Matériau : Glass | Verre  
Lampshade gallerie | Griffe : Ø57mm  
Compatible with the shade adaptor ref GS 289204 | Compatible avec la griffe de suspension ref GS 289204



Clear glass suspension compatible with the lampshade gallery ref: 289204 | Suspension en verre clair compatible avec la griffe de suspension ref : 289204

# Electric oil lamp burner

Bec pour lampe pétrole électrique

360301



## Description

Material | Matériau : Polished brass | Laiton poli

Dimensions : 49 x Ø45mm

Gallery with base, welded key and pedestal for E14 lampholder - 14" | Galerie avec embase, clé soudée et piedouche pour douille E14 - calibre 14"

# Electric oil lamp burners

Becs pour lampe pétrole électrique

360513



12"  
49 x Ø45mm

360535



8"  
46 x Ø39mm



## Description

Material | Matériau : Polished brass | Laiton poli

# Glasswares for Mazda lamps

Verreries pour lampes Mazda

365063



Hole | Trou : Ø28mm  
Height | Hauteur : 140mm  
Diameter | Diamètre : Ø160mm

365074



Hole | Trou : Ø28mm  
Height | Hauteur : 190mm  
Diameter | Diamètre : Ø205mm

365085



Hole | Trou : Ø40mm  
Height | Hauteur : 190mm  
Diameter | Diamètre : Ø205mm

365096



Hole | Trou : Ø40mm  
Height | Hauteur : 220mm  
Diameter | Diamètre : Ø260mm

## Description

Material | Matériau : Glass | Verre  
Color | Couleur : Opal | Opale

# Glass lampshades for oil lamps

Verreries pour lampes à pétrole

700017

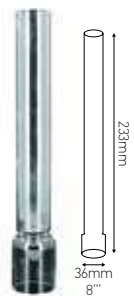

Kosmos 8''

700028



Kosmos 10''

700039



Kosmos 12''

700040



Kosmos 14''

## Description

Material | Matériau : Glass | Verre  
Color | Couleur : Clear | Clair

# Glass lampshades for oil lamps

Verreries pour lampes à pétrole

700051



Satin | Satiné  
Matador 15"

700062



Clear | Clair  
Matador 15"

700073



Satin | Satiné  
Matador 15"

700084



Clear | Clair  
Matador 20"

700095



Satin | Satiné  
Matador 20"

## Description

Material | Matériau : Glass | Verre

# Glass lampshade for oil lamps

Verrerie pour lampes à pétrole

700101

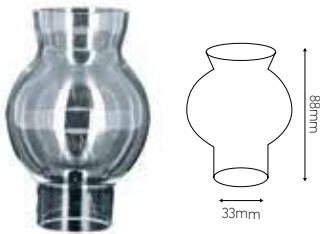

Clear | Clair  
Pigeon

## Description

Material | Matériau : Glass | Verre

# Glass lampshades for oil lamps

Verreries pour lampes à pétrole

700223



Convex "Viennois" | Bombés «Viennois»  
Clear | Clair

700245

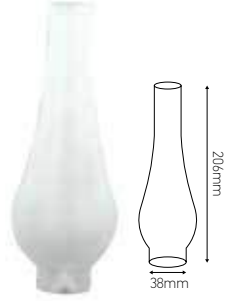

Convex "Viennois" | Bombés «Viennois»  
Satin | Satiné

700267

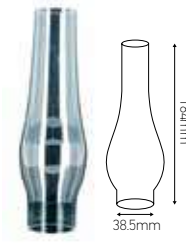

Rochester  
Clear | Clair

700289

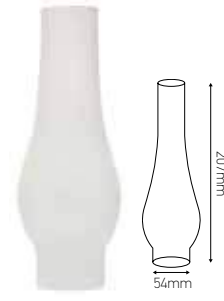

Rochester  
Satin | Satiné

## Description

Material | Matériau : Glass | Verre

# Glass lampshades for oil lamps

Verreries pour lampes à pétrole

700335



Clear | Clair

700346

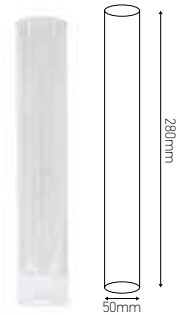

Clear | Clair

700379

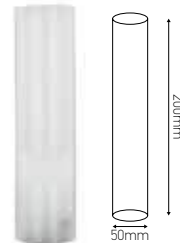

Satin | Satiné

## Description

Material | Matériau : Glass | Verre  
Cylindrical glass | Verre cylindrique

# Accessories for oil lamps

Accessoires pour lampes à pétrole

700415



Kosmos 8"

700448



Kosmos 14"

## Description

Material | Matériau : Polished brass | Laiton poli  
Kosmos burner with wick | Bec méché kosmos

# Accessories for oil lamps

Accessoires pour lampes à pétrole

700748



200 x 48mm  
Wick 10" | Mèche frangée 10"

700759



200 x 55mm  
Wick 12" | Mèche frangée 12"

700761

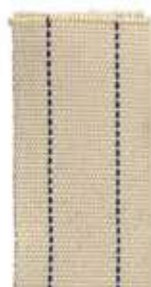

200 x 64mm  
Wick 14" | Mèche frangée 14"

700783



140 x 5mm  
Wick pigeon | Mèche pigeon



# Vesta glasswares

Verreries Vesta

703001



703012



703023



703034



703045



703059

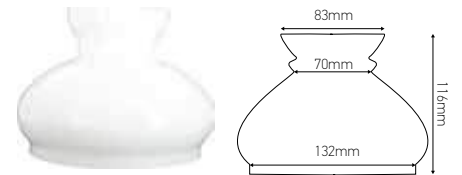

703060

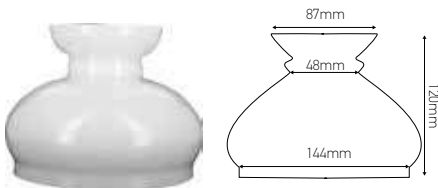

703072



703096

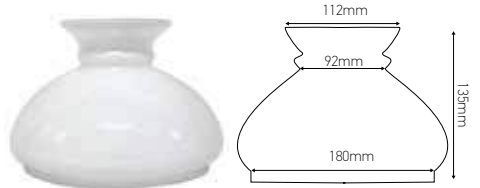

703107

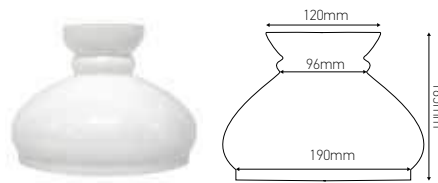

703120



703186

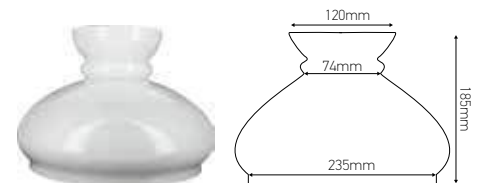

703325

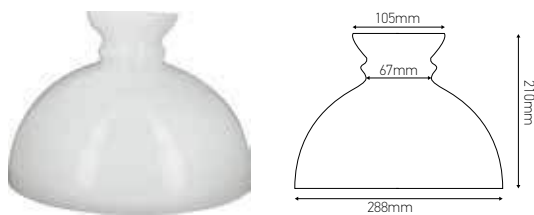

703336



## Description

Material | Matériau : Glass | Verre

Color | Couleur : Opal | Opale

## Satin etched globes “Louis XV” style

Globes satinés gravure style « Louis XV »

705263



Ø130 x 115mm

705274



Ø150 x 137mm

705285



Ø180 x 160mm

705296



Ø200 x 195mm

### Description

Satin opal | Opale satiné

Material | Matériau : Glass | Verre

Color | Couleur : Satin opal | Opale satiné

## Satin etched tulip

Tulipe satinée gravée

706426



Ø90 x 115mm

### Description

Material | Matériau : Glass | Verre

Hole | Trou : 28mm

Color | Couleur : Satin opal | Opale satiné

# Glass lampshades

Suspensions en verre

710505



Ø210 x 220mm

710507



Ø110 x 250mm

## Description

Material | Matériau : Glass | Verre

Transparent

Hole | Trou : 42mm

Glass lampshades for lampholders with rings and mountings | Suspensions en verre pour douilles avec bagues et montures

# “Empire“ style candle glasswares

Verreries flamme style « Empire »

713475



Lampshade gallerie | Griffe : 57mm  
Ø90 x 125mm

713488



Lampshade gallerie | Griffe : 80mm  
Ø110 x 165mm

713517



Lampshade gallerie | Griffe : 100mm  
Ø170 x 220mm

## Description

Material | Matériau : Glass | Verre

Color | Couleur : Satin opal | Opale satiné

# Tulip glasswares

Verreries tulipe

710601



Ø80 x 98mm

710612



Ø90 x 115mm

## Description

Material | Matériau : Glass | Verre

Hole | Trou : Ø28mm

Color | Couleur : Satin opal | Opale satiné

# Vintage style “Épi” tulip glasswares

Verreries tulipe « Épi » style vintage

712069



Transparent  
Clear edge | Bord clair

715115



Transparent  
Black edge | Bord noir

715137



Transparent  
Ruby edge | Bord rubis

715168



Transparent  
Amber edge | Bord ambré

## Description

Material | Matériau : Glass | Verre

Lampshade galleries | Griffes : 57mm

Dimensions : Ø145 x 110mm

# “Art Deco” style tulip glasswares

Verreries tulipe style « Art Déco »

714663



Lampshade gallerie | Griffe : 57mm  
Ø107 x 136mm

714685



Lampshade gallerie | Griffe : 28mm  
Ø100 x 133mm

714696



Lampshade gallerie | Griffe : 28mm  
Ø98 x 129mm

## Description

Material | Matériau : Glass | Verre  
Transparent

# “Art Deco” style dome glassware

Verrerie dôme style « Art Déco »

714828



Ø107 x 136mm

## Description

Material | Matériau : Glass | Verre  
Transparent

# Opale lampshades

Abat-jours opales

730367



Ø250 x 55mm

730502



Ø224 x 112mm



## Description

Lampshade gallerie | Griffe : 57mm  
 Material | Matériau : Glass | Verre  
 Color | Couleur : Opal | Opale

# Opale globes

Globes opales

705005



Ø130 x 115mm

705027



Ø150 x 137mm

705038



Ø180 x 160mm

744342



Ø80 x 150mm

744353



Ø200 x 200mm

744495



Ø100 x 100mm  
 Neck | Col : 50mm

744496



Ø120 x 120mm  
 Neck | Col : 50mm

## Description

Material | Matériau : Glass | Verre  
 Color | Couleur : Opal | Opale

# Opale globes

Globes opales

744497



Hole | Trou : Ø40mm  
Ø100 x 95mm

744518



Hole | Trou : Ø40mm  
Ø130 x 126mm

744529



Hole | Trou : Ø40mm  
Ø150 x 150mm

744531



Hole | Trou : Ø28mm  
Ø130 x 112mm

## Description

Material | Matériau : Glass | Verre  
Color | Couleur : Opal | Opale

# Tulip shades for chandeliers

Tulipes pour lustres

744603



Ø103 x 80mm  
Satin | Satinée

744624



Ø135 x 100mm  
Satin | Satinée

744626



Ø135 x 100mm  
Satin - amber edge  
Satinée - bord ambré

## Description

Material | Matériau : Glass | Verre  
Hole | Trou : 28mm  
Tulip Button - 5 petals -Satin glass | Tulipe bouton - 5 pétales -Verre satiné

# Tulip shade for chandeliers

Tulipe pour lustres

745234



Ø100 x 114mm

## Description

Hole | Trou : 45mm

Optical glass sides -Glossy amber | Côtes optiques verre -Lustré ambre

# Tulips shades for chandeliers

Tulipes pour lustres

745367



Glossy amber glass | Verre lustré ambre

Hole | Trou : 48mm

Ø117 x 130mm

745478



Satin, clear etch | Satinée, gravure claire

Neck | Col : 50mm

Ø130 x 135mm

745480



Satin amber, clear etch

Satinée ambre, gravure claire

Neck | Col : 50mm

Ø140 x 115mm

745490



Etched satin, amber edges - twisted sides

Satinée gravée, bord ambre côtes torsadées

Neck | Col : 55mm

Ø117 x 130mm



# Satin etched globes for chandeliers

Globes satinés gravés pour lustres

745498



Satin, clear etch  
Satinée, gravure claire  
Ø120 x 120mm

745500



Satin, clear etch  
Satinée, gravure claire  
Ø137 x 140mm

745501



Glossy amber, clear etch  
Lustrée ambre, gravure claire  
Ø120 x 130mm

745505



Amber satin, clear etch  
Satinée ambre, gravure claire  
Ø137 x 140mm

745510



Amber satin, clear etch  
Satinée ambre, gravure claire  
Ø140 x 150mm

## Description

Neck | Col : 50mm

# Accessories for chandeliers

Accessoires pour lustres

739499



Ivory | Ivoire

739523



Antique gold | Vieil or



## Description

Cable length | Longueur du câble : 0.5m

Textile cord with canopy and S-hook, twisted cable wire 1 x 0.5mm<sup>2</sup>, with E27 white lacquered lampholder

Cordelière avec pavillon et esse, câble torsadé 1 x 0.5mm<sup>2</sup>, avec douille blanc laqué E27

# Wall lamps "Swan Neck"

Appliques « Col de cygne »

756571



Polished and lacquered brass  
Laiton poli verni

756591



Chrome-plated brass  
Laiton chromé



# False candles

Fausses bougies



# Candle sleeves without drips

Fourreaux sans gouttes

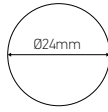

- 200106** Ø24 x 65mm
- 200107** Ø24 x 70mm
- 200108** Ø24 x 80mm
- 200109** Ø24 x 85mm
- 200110** Ø24 x 100mm
- 200112** Ø24 x 120mm
- 200118** Ø24 x 170mm
- 200121** Ø24 x 230mm

## Description

Colour | Couleur : Antique white | Blanc antique

Material | Matériau : Cardboard | Carton rigide

For candle lampholder E14 - 22.5mm diameter | Pour douille fourreau E14 - 22,5mm de diamètre



# Candle sleeve without drips in opal glass

Fourreau sans gouttes en verre opale



Ø25 x 100mm

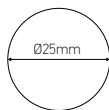

## Description

For candle lampholder E14 - 22.5mm diameter | Pour douille fourreau E14 - 22,5mm de diamètre

Colour | Couleur : White | Blanc

Material | Matériau : Opal glass | Verre opale

# Candle sleeves with drips

Fourreaux avec gouttes



Antique white | Blanc antique



Antique ivory | Ivoire patiné



Antique cardboard | Carton patiné



Covered with wax cardboard  
Carton recouvert de cire

Glow wire  
650°

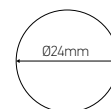

**200143** Ø24 x 65mm  
**200145** Ø24 x 70mm  
**200148** Ø24 x 80mm  
**200151** Ø24 x 85mm  
**200153** Ø24 x 100mm

**200216** Ø24 x 65mm  
**200237** Ø24 x 70mm  
**200248** Ø24 x 80mm  
**200249** Ø24 x 85mm  
**200250** Ø24 x 100mm

**200345** Ø24 x 65mm  
**200347** Ø24 x 70mm  
**200348** Ø24 x 80mm  
**200349** Ø24 x 85mm  
**200350** Ø24 x 100mm

**200467** Ø24 x 70mm  
**200468** Ø24 x 80mm  
**200470** Ø24 x 100mm  
**200472** Ø24 x 120mm  
**200523** Ø24 x 230mm

## Description

Material | Matériau : Cardboard | Carton rigide

For candle lampholder E14 diameter 22.5mm | Pour douille fourreau E14 - 22,5mm de diamètre

# Candle lampholders E14

Supports bougies E14

201016



Ø23 x 85mm

201027



Ø23 x 100mm

2A  
250V

Glow wire  
650°

T 135°C



EN 60238

## Description

Material | Matériau : Thermoplastic | Thermoplastique

Automatic Terminals | Bornes automatiques

Female thread 10 x 1 | Femelle 10 x 1

Metal threaded 10 x 1, locking screw | Raccord métal 10 x 1, vis d'arrêt

# Candle lampholders E14

Supports bougies E14

201047



Ø23.5 x 65mm

201059



Ø23.5 x 80mm

2A  
250V

Glow wire  
650°

T 135°C



## Description

Finish | Finition : Thermosetting insulation | Isolant thermodurcissable  
 Female thread 10 x 1 | Femelle 10 x 1  
 Metal threaded 10 x 1, locking screw | Raccord métal 10 x 1, vis d'arrêt

# Candle lampholder E14

Support bougie E14

201062



Ø23.5 x 100mm

2A  
250V

Glow wire  
650°

T 135°C



## Description

Finish | Finition : Thermosetting insulation | Isolant thermodurcissable

# Candle lampholders E14

Supports bougies E14

201072



Ø23.5 x 65mm

201084



Ø23.5 x 85mm

201096



Ø23.5 x 100mm

201092



Ø22.5 x 95 - 120mm

2A  
250V

Glow wire  
650°

T 135°C



## Description

Finish | Finition : Thermosetting insulation | Isolant thermodurcissable  
Female burner | Femelle becs  
Metal thread | Raccord métal

## Description

Finish | Finition : Thermosetting insulation | Isolant thermodurcissable  
Female thread 10 x 1 | Femelle 10 x 1  
Adjustable | Réglable

# Candle lampholder E14

Support bougie E14

201117



Ø26 x 70mm

2A  
250V

Glow wire  
650°

T 135°C



EN 60238

## Description

Finish | Finition : Thermosetting insulation | Isolant thermodurcissable  
Female thread 10 x 1 | Femelle 10 x 1  
Metal threaded 10 x 1, locking screw | Raccord métal 10 x 1, vis d'arrêt  
Plastic screw lug | Vis de serrage en plastique

# Candle sleeves with drips

Fourreaux avec gouttes

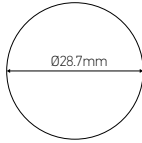

Antique finish wax | Cire patinée

- 201617** Ø28.7 x 70mm
- 201619** Ø28.7 x 85mm
- 201620** Ø28.7 x 100mm

## Description

Finish | Finition : Tinted plastic lacquered wax | Plastique teinté cire patinée  
For lampholder E14 - 26mm diameter | Pour support E14 - 26mm de diamètre

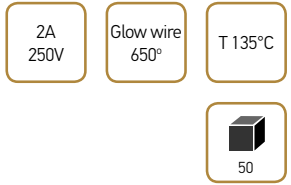

EN 60238

# Candle sleeves with drips

Fourreaux avec gouttes

202017



Antique cardboard  
Carton patiné  
Ø27 x 70mm

202019



Antique cardboard  
Carton patiné  
Ø27 x 85mm

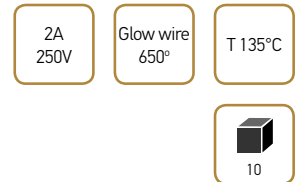
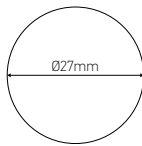

EN 60238

202052



Antique white | Blanc antique  
Ø27 x 70mm

202074



Antique white | Blanc antique  
Ø27 x 100mm

202246



Antique ivory | Ivoire patiné  
Ø27 x 70mm

202259



Antique ivory | Ivoire patiné  
Ø27 x 85mm

## Description

Finish | Finition : Cardboard | Carton rigide  
For lampholder E14 - 26mm diameter | Pour support E14 - 26mm de diamètre



# Candle sleeve without drips

Fourreau sans gouttes

202041



Antique white | Blanc antique  
Ø27 x 70mm

2A  
250V

Glow wire  
650°

T 135°C



EN 60238

## Description

Finish | Finition : Cardboard | Carton rigide  
For lampholder E14 diameter 26mm | Pour douille E14 - 26mm de diamètre



# Candles “Grand siècle” The classics

Bougies « Grand siècle » Les classiques

205337



Ø22 x 170mm

206610



Ø22 x 110mm

206627



Ø22 x 170mm

206643



Ø22 x 230mm

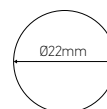

EN 60598

## Description

Color | Couleur : Satin ivory | Ivoire satiné

Registered model | Modèle déposé

Cylindrical candle with a 22mm Ø base | Bougie cylindrique avec un Ø de base de 22mm

Locking ribs (glueing recommended) | Nervures de blocage (collage conseillé)

Candle cups | Bobèche

Cable : 1 m tinned crystal | Câble : 1m cristal étamé H03VH-2F - 2 x 0.50mm<sup>2</sup>

# Candles “Grand siècle” The modern

Bougies « Grand siècle » Les modernes

205727



Ø22 x 170mm

205743



Ø22 x 230mm



EN 60598

## Description

Color | Couleur : Satin ivory | Ivoire satiné

Registered models | Modèles déposés

Cylindrical candle without base | Bougies cylindriques sans talon

# Candle “Grand siècle” The modern

Bougie « Grand siècle » Les modernes

206850



Ø22 x 110mm



EN 60598

## Description

Color | Couleur : Satin ivory | Ivoire satiné

Registered model | Modèle déposé

Conical candle without base | Bougie conique sans talons

With brake nut female 10 x 1 | Avec écrou frein femelle 10 x 1

Delivered non-assembled. Integrated terminal block in the double candle shell | Livrées non assemblées. Bornier de connexion intégré dans la double coque

Direct connection of the double insulation cable from the lighting fixture on this terminal block | Raccordement direct du câble double isolation du luminaire sur ce bornier

# Candles “Grand siècle” The modern

Bougies « Grand siècle » Les modernes

206877



Ø22 x 170mm

206893



Ø22 x 230mm



EN 60598

## Description

Color | Couleur : Satin ivory | Ivoire satiné

Registered model | Modèle déposé

Cylindrical candle, electronic circuit causing a variation in the intensity of the candle lamp “Grand Siècle” 7W - 230/240 V

Bougie cylindrique, circuit électronique entraînant une variation de l'intensité de la lampe flamme «Grand Siècle», 7W - 230/240 V

E10 lampholder with base | Douille E10 avec talon

Cable : 1m tinned crystal, H03VVH-2F - 2 x 0.50mm<sup>2</sup> | Douille : 1m cristal étamé, H03VVH-2F - 2 x 0.50mm<sup>2</sup>

# Candle “La Vacillante”

Bougie « La Vacillante »

205800



Ø22 x 170mm



EN 60598

## Description

Color | Couleur : Satin ivory | Ivoire satiné

Registered model | Modèle déposé

Cylindrical candle, electronic circuit causing a variation in the intensity of the candle lamp “Grand Siècle” 7W - 230/240 V |

Bougie cylindrique, circuit électronique entraînant une variation de l'intensité de la lampe flamme « Grand Siècle », 7W - 230/240 V

E10 lampholder with base | Douille E10 avec talon

Cable : 1m tinned crystal, H03VVH-2F - 2 x 0.50mm<sup>2</sup> | Douille: 1m cristal étamé, H03VVH-2F - 2 x 0.50mm<sup>2</sup>

# “Vivaflam” candle

Bougie « Vivaflam »

204632



## Description

Finish | Finition : Plastic | Plastique

3W lamp with counterweight | Lampe 3W avec contrepoids

# “Vivaflam” candle

Bougie « Vivaflam »

204634



Height | Hauteur : 100mm

## Description

Finish | Finition : Plastic | Plastique

Socket E14 - Electronic mechanism for candle 230V | Culot E14 - Mécanisme électronique pour bougie 230V

# “Vivaflam” candle

Bougie « Vivaflam »

204635



Ø23.5 x 200mm

## Description

Finish | Finition : Plastic | Plastique

Socket E14 - Candle 230V | Culot E14 - Bougie 230V

Cylindrical candle, plastic material, electronic circuit creating a pendulum movement of the 3W lamp

Bougie cylindrique, matière plastique circuit électronique créant un mouvement pendulaire de la lampe 3W

Plastic sleeve (cut to the desired height) | Fourreau plastique (couper à la hauteur désirée)



# Belt lights

Guirlandes lumineuses





© Michel Bousquet pour Le Grand appartement



# E27 belt lights 5m with 5 lampholders 2 x 1.5mm<sup>2</sup>

Guirlandes lumineuses avec 5 douilles E27

AC  
220-240V  
50/60Hz



EN 60598-2-20  
EN 50525-2-11  
EN 62321

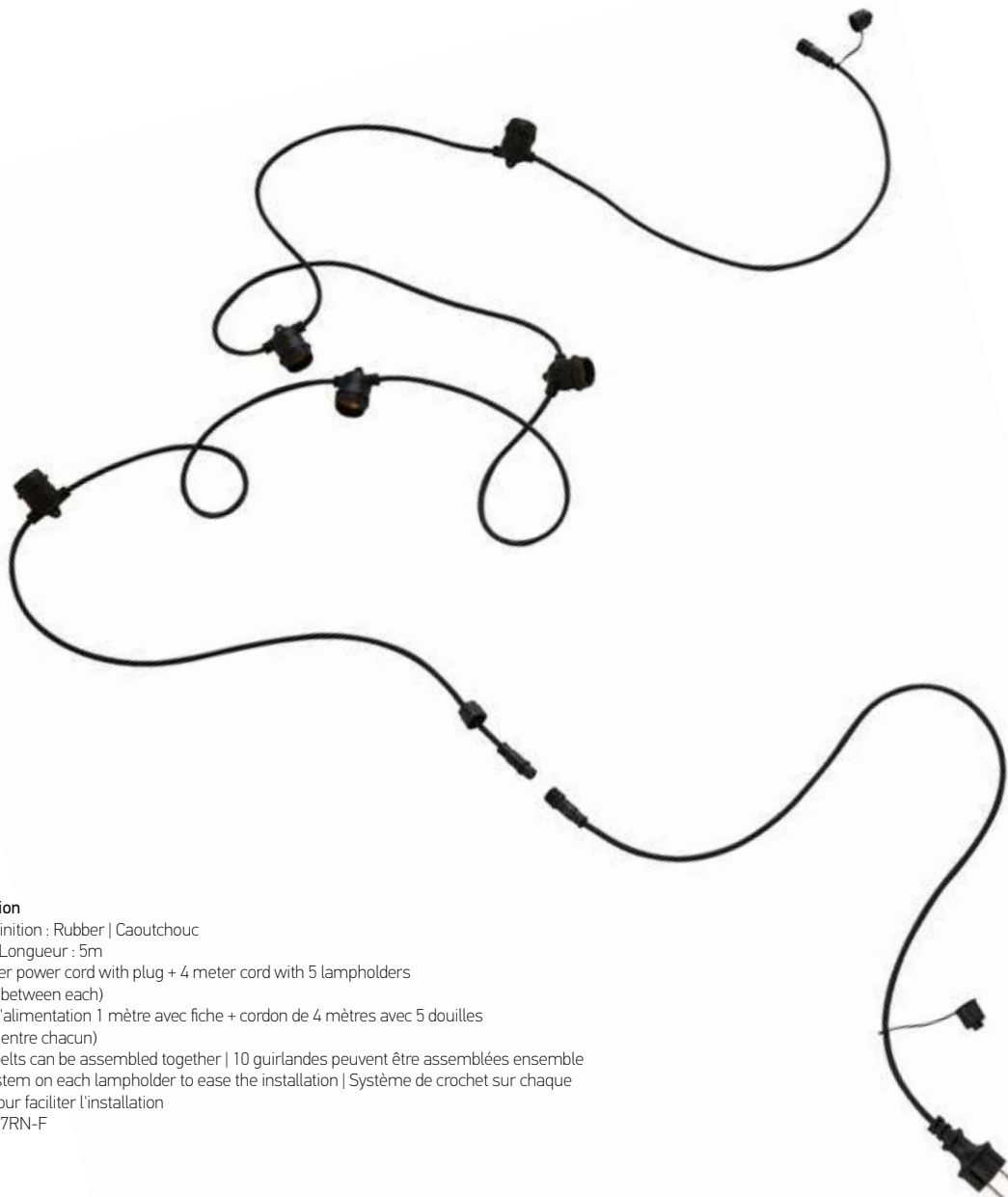

## Description

Finish | Finition : Rubber | Caoutchouc

Length | Longueur : 5m

One meter power cord with plug + 4 meter cord with 5 lampholders  
(62,5 cm between each)

Cordon d'alimentation 1 mètre avec fiche + cordon de 4 mètres avec 5 douilles  
(62,5 cm entre chacun)

10 light belts can be assembled together | 10 guirlandes peuvent être assemblées ensemble

Hook system on each lampholder to ease the installation | Système de crochet sur chaque douille pour faciliter l'installation

Type : H07RN-F

158009



Green | Vert

158011



Black | Noir

158014



White | Blanc

# Sphericals LED (1W) E27

Sphériques LED E27



160136  
Red | Rouge



160137  
Yellow | Jaune



160138  
Blue | Bleu



160139  
Green | Vert



162040  
Natural white  
Blanc naturel



161140  
Warm white  
Blanc chaud



**Description**

Finish | Finition : Polycarbonate

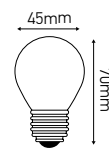

48 x 48 x 85mm



# 5 sphericals LED kit (1W) E27

5 sphériques LED

## 158018 Classic kit



Red | Rouge    Yellow | Jaune    Blue | Bleu    Green | Vert    White | Blanc

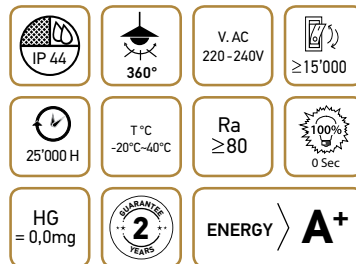
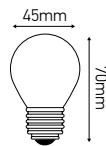

## 158019 Jazz kit



Antique pink  
Vieux rose    Pastel violet  
Violet pastel    Light green  
Vert clair    White aluminium  
Aluminium blanc    Light ivory  
Ivoire clair

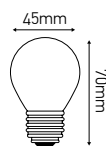

235 x 48 x 85mm

## 158020 Pop kit



Raspberry | Framboise    Purple | Violet    Blue | Bleu    Orange    Yellow | Jaune

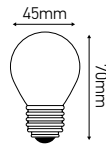

## 158022 Warm white kit



Warm white | Blanc chaud

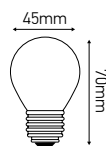

### Description

Finish | Finition : Polycarbonate

# Metallic lampshades Ø187mm with fixing rubber ring

Abat-jours métalliques avec bague de fixation en caoutchouc

187600



Black | Noir

187601



White | Blanc

187602



Pink | Rose



## Description

Finish | Finition : Aluminium

Hole | Trou : Ø35mm

Height | Hauteur : 25mm

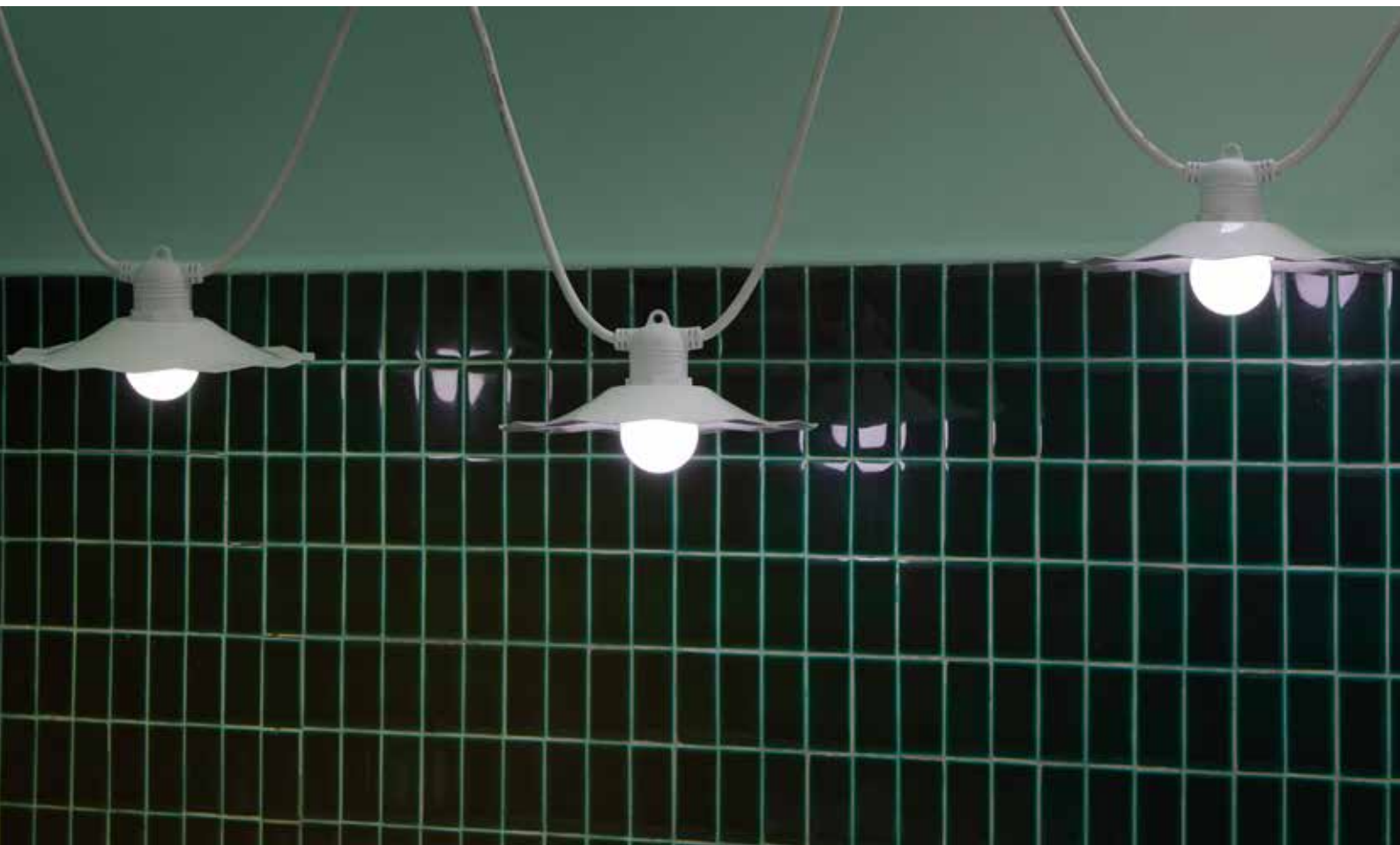
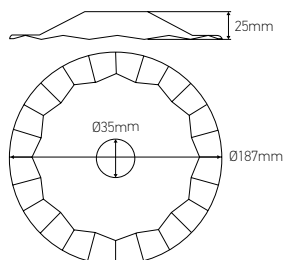



# Summary of references

Récapitulatif des références

Ref.	PAGE	EAN	Ref.	PAGE	EAN	Ref.	PAGE	EAN	Ref.	PAGE	EAN
142529	176	3125461425296	162040	234	3125461620400	187548	32	3125461875480	187602	236	3125461876029
142693	72	3125461426934	164801	129	3125461648015	187549	32	3125461875497	187875	46	3125461878757
153373	77	3125461533731	164809	129	3125461648091	187550	30	3125461875503	187876	46	3125461878764
155463	110	3125461554637	164811	130	3125461648114	187551	30	3125461875510	189600	25	3125461896003
155556	142	3125461555566	164812	130	3125461648121	187552	32	3125461875527	189601	25	3125461896010
155731	110	3125461557317	167438	198	3125461674380	187553	31	3125461875534	189602	25	3125461896027
155733	110	3125461557331	167510	16	3125461675103	187554	28	3125461875541	189603	25	3125461896034
155735	110	3125461557355	167511	16	3125461675110	187557	12	3125461875572	189604	26	3125461896041
155736	110	3125461557362	167512	17	3125461675127	187558	12	3125461875589	189605	26	3125461896058
155737	110	3125461557379	167513	17	3125461675134	187559	12	3125461875596	189606	26	3125461896065
155738	110	3125461557386	167514	17	3125461675141	187560	12	3125461875602	189607	26	3125461896072
156629	143	3125461566296	167515	17	3125461675158	187561	12	3125461875619	189608	26	3125461896089
157163	85	3125461571634	167518	13	3125461675189	187562	12	3125461875626	189609	26	3125461896096
158009	233	3125461580094	167519	13	3125461675196	187563	13	3125461875633	189610	24	3125461896102
158011	233	3125461580117	187515	14	3125461875152	187564	33	3125461875640	189611	24	3125461896119
158014	233	3125461580148	187516	14	3125461875169	187565	33	3125461875657	189612	24	3125461896126
158018	235	3125461580186	187517	14	3125461875176	187566	33	3125461875664	189613	24	3125461896133
158019	235	3125461580193	187518	18	3125461875183	187567	33	3125461875671	189614	24	3125461896140
158020	235	3125461580209	187519	18	3125461875190	187568	34	3125461875688	189615	24	3125461896157
158022	235	3125461580223	187520	18	3125461875206	187569	34	3125461875695	189616	24	3125461896164
158063	28	3125461580636	187521	18	3125461875213	187570	34	3125461875701	189617	24	3125461896171
158265	134	3125461582654	187522	19	3125461875220	187571	31	3125461875718	189618	24	3125461896188
158267	134	3125461582678	187523	19	3125461875237	187572	19	3125461875725	189619	24	3125461896195
158269	134	3125461582692	187524	19	3125461875244	187573	19	3125461875732	189620	24	3125461896201
158339	143	3125461583392	187525	20	3125461875251	187574	21	3125461875749	189621	26	3125461896218
158459	134	3125461584597	187526	20	3125461875268	187575	21	3125461875756	189622	26	3125461896225
158461	134	3125461584610	187527	20	3125461875275	187576	21	3125461875763	189623	27	3125461896232
158463	134	3125461584634	187528	20	3125461875282	187577	21	3125461875770	189624	27	3125461896249
158465	134	3125461584658	187529	22	3125461875299	187578	21	3125461875787	189625	27	3125461896256
158479	144	3125461584795	187530	23	3125461875305	187579	12	3125461875794	189626	26	3125461896263
158498	141	3125461584986	187531	25	3125461875312	187580	25	3125461875800	189627	26	3125461896270
158657	126	3125461586577	187532	23	3125461875329	187581	25	3125461875817	189628	26	3125461896287
158703	124	3125461587031	187533	25	3125461875336	187582	25	3125461875824	189629	27	3125461896294
158705	124	3125461587055	187534	25	3125461875343	187584	37	3125461875848	189630	26	3125461896300
158707	124	3125461587079	187535	25	3125461875350	187585	14	3125461875855	189631	27	3125461896317
158709	124	3125461587093	187536	25	3125461875367	187586	37	3125461875862	189632	27	3125461896324
158844	141	3125461588441	187537	25	3125461875374	187587	19	3125461875879	189633	27	3125461896331
158852	120	3125461588526	187538	25	3125461875381	187588	38	3125461875886	189634	26	3125461896348
158854	117	3125461588540	187539	25	3125461875398	187589	40	3125461875893	189635	27	3125461896355
158856	70	3125461588564	187540	28	3125461875404	187590	202	3125461875909	189636	27	3125461896362
158858	120	3125461588588	187541	28	3125461875411	187591	202	3125461875916	189637	27	3125461896379
158860	117	3125461588601	187542	28	3125461875428	187596	39	3125461875961	189638	26	3125461896386
160136	234	3125461601362	187543	30	3125461875435	187597	39	3125461875978	189639	26	3125461896393
160137	234	3125461601379	187544	30	3125461875442	187598	23	3125461875985	189640	27	3125461896409
160138	234	3125461601386	187545	29	3125461875459	187599	23	3125461875992	189641	27	3125461896416
160139	234	3125461601393	187546	29	3125461875466	187600	236	3125461876005	189642	27	3125461896423
161140	234	3125461611408	187547	32	3125461875473	187601	236	3125461876012	189643	27	3125461896430

# Summary of references

Récapitulatif des références

Ref.	PAGE	EAN	Ref.	PAGE	EAN	Ref.	PAGE	EAN	Ref.	PAGE	EAN
200106	220	3125462001062	202246	224	3125462022463	213193	57	3125462131936	214563	63	3125462145636
200107	220	3125462001079	202259	224	3125462022593	213197	57	3125462131974	214584	70	3125462145841
200108	220	3125462001086	204632	228	3125462046322	213291	57	3125462132919	214591	63	3125462145919
200109	220	3125462001093	204634	229	3125462046346	213293	57	3125462132933	215051	67	3125462150517
200110	220	3125462001109	204635	229	3125462046353	213297	57	3125462132971	215053	67	3125462150531
200112	220	3125462001123	205337	226	3125462053375	213351	61	3125462133510	215057	67	3125462150579
200118	220	3125462001185	205727	226	3125462057274	213353	61	3125462133534	215271	67	3125462152719
200121	220	3125462001215	205743	226	3125462057434	213357	61	3125462133572	215273	67	3125462152733
200143	221	3125462001437	205800	228	3125462058004	213511	58	3125462135118	215275	67	3125462152757
200145	221	3125462001451	206610	226	3125462066108	213513	58	3125462135132	216071	54	3125462160714
200148	221	3125462001482	206627	226	3125462066276	213517	58	3125462135170	216073	54	3125462160738
200151	221	3125462001512	206643	226	3125462066436	213521	58	3125462135217	216091	54	3125462160912
200153	221	3125462001536	206850	227	3125462068508	213523	58	3125462135231	216111	52	3125462161117
200216	221	3125462002168	206877	227	3125462068775	213527	58	3125462135279	216113	52	3125462161131
200237	221	3125462002373	206893	227	3125462068935	213531	58	3125462135316	216117	52	3125462161179
200248	221	3125462002489	210206	71	3125462102066	213533	58	3125462135330	216121	52	3125462161216
200249	221	3125462002496	210215	71	3125462102158	213537	58	3125462135378	216123	52	3125462161230
200250	221	3125462002502	210221	71	3125462102219	213573	61	3125462135736	216127	52	3125462161278
200345	221	3125462003455	210226	71	3125462102264	213611	59	3125462136115	216131	52	3125462161315
200347	221	3125462003479	210229	71	3125462102295	213613	59	3125462136139	216133	52	3125462161339
200348	221	3125462003486	210247	72	3125462102479	213617	59	3125462136177	216137	52	3125462161377
200349	221	3125462003493	210258	72	3125462102585	213621	59	3125462136214	216265	54	3125462162657
200350	221	3125462003509	210298	73	3125462102981	213623	59	3125462136238	216311	51	3125462163111
200467	221	3125462004674	210385	73	3125462103858	213627	59	3125462136276	216313	51	3125462163135
200468	221	3125462004681	210587	74	3125462105876	213631	59	3125462136313	216317	51	3125462163173
200470	221	3125462004704	210589	74	3125462105890	213633	59	3125462136337	216321	51	3125462163210
200472	221	3125462004728	210596	79	3125462105968	213637	59	3125462136375	216323	51	3125462163234
200523	221	3125462005237	210597	79	3125462105975	213663	62	3125462136634	216327	51	3125462163272
200590	220	3125462005909	210598	79	3125462105982	213911	60	3125462139116	216331	51	3125462163319
201016	221	3125462010163	210599	79	3125462105999	213913	60	3125462139130	216333	51	3125462163333
201027	221	3125462010279	210690	74	3125462106903	213917	60	3125462139178	216337	51	3125462163371
201047	222	3125462010477	210692	74	3125462106927	213921	60	3125462139215	216391	50	3125462163913
201059	222	3125462010590	210731	79	3125462107313	213923	60	3125462139239	216393	50	3125462163937
201062	222	3125462010620	210853	79	3125462108532	213927	60	3125462139277	216397	50	3125462163975
201072	223	3125462010729	210879	69	3125462108792	213931	60	3125462139314	216501	50	3125462165016
201084	223	3125462010842	210882	36	3125462108822	213933	60	3125462139338	216503	50	3125462165030
201092	223	3125462010927	210883	36	3125462108839	213937	60	3125462139376	216507	50	3125462165078
201096	223	3125462010965	210884	36	3125462108846	214421	65	3125462144219	216571	50	3125462165719
201117	223	3125462011177	210888	69	3125462108884	214423	65	3125462144233	216573	50	3125462165733
201617	224	3125462016172	210889	69	3125462108891	214427	65	3125462144271	216577	50	3125462165771
201619	224	3125462016196	210979	69	3125462109799	214444	70	3125462144448	218063	55	3125462180637
201620	224	3125462016202	210988	69	3125462109881	214451	65	3125462144516	218401	64	3125462184017
202017	224	3125462020179	210989	69	3125462109898	214453	65	3125462144530	218403	64	3125462184031
202019	224	3125462020193	213091	57	3125462130915	214457	65	3125462144578	218407	64	3125462184079
202041	225	3125462020414	213093	57	3125462130939	214513	63	3125462145131	218421	64	3125462184215
202052	224	3125462020520	213097	57	3125462130977	214514	70	3125462145148	218423	64	3125462184239
202074	224	3125462020742	213191	57	3125462131912	214534	70	3125462145346	218427	64	3125462184277

# Summary of references

Récapitulatif des références

Ref.	PAGE	EAN	Ref.	PAGE	EAN	Ref.	PAGE	EAN	Ref.	PAGE	EAN
218433	64	3125462184338	230851	181	3125462308512	233542	190	3125462335426	236527	98	3125462365270
218733	56	3125462187339	230983	181	3125462309830	233610	190	3125462336102	236763	97	3125462367632
219321	55	3125462193217	230991	181	3125462309915	233611	190	3125462336119	236853	98	3125462368530
219331	35	3125462193316	231003	182	3125462310034	233613	190	3125462336133	236969	106	3125462369698
219341	35	3125462193415	231011	182	3125462310119	233615	191	3125462336157	236974	106	3125462369742
220879	68	3125462208799	231029	182	3125462310294	233629	191	3125462336294	236982	98	3125462369827
220881	68	3125462208812	231139	182	3125462311390	233686	193	3125462336867	237043	92	3125462370434
220882	35	3125462208829	231159	182	3125462311598	233705	191	3125462337055	237051	92	3125462370519
220883	35	3125462208836	231507	183	3125462315077	233709	191	3125462337093	237062	92	3125462370625
220884	35	3125462208843	231614	183	3125462316142	233717	192	3125462337178	237077	92	3125462370779
220885	35	3125462208850	231627	183	3125462316272	233728	192	3125462337284	237079	92	3125462370793
220888	68	3125462208881	231747	184	3125462317477	233731	194	3125462337314	237094	92	3125462370946
220889	68	3125462208898	231889	184	3125462318894	233742	194	3125462337420	237133	93	3125462371332
220936	68	3125462209369	231902	184	3125462319020	233753	193	3125462337536	237141	93	3125462371417
220969	69	3125462209697	231905	184	3125462319051	233806	194	3125462338069	237142	93	3125462371424
220979	68	3125462209796	232391	183	3125462323911	233816	194	3125462338168	237147	93	3125462371479
220981	68	3125462209819	232393	183	3125462323935	233836	195	3125462338366	237149	93	3125462371493
220988	68	3125462209888	232561	184	3125462325618	233856	195	3125462338564	237331	94	3125462373312
220989	68	3125462209895	232584	187	3125462325847	235011	90	3125462350115	237457	94	3125462374579
221014	75	3125462210143	232604	185	3125462326042	235017	90	3125462350177	237487	93	3125462374876
221123	75	3125462211232	232609	185	3125462326097	235025	90	3125462350252	237571	88	3125462375712
221246	76	3125462212468	232612	185	3125462326127	235147	90	3125462351471	237572	88	3125462375729
221342	76	3125462213427	232617	185	3125462326172	235155	90	3125462351556	237577	88	3125462375774
221461	66	3125462214615	232619	185	3125462326196	235753	90	3125462357534	237647	89	3125462376474
221463	66	3125462214639	232763	185	3125462327636	235771	90	3125462357718	237648	89	3125462376481
221467	66	3125462214677	232771	185	3125462327711	235799	90	3125462357992	237711	88	3125462377112
221681	66	3125462216817	232791	185	3125462327919	235833	95	3125462358333	237881	88	3125462378812
221683	66	3125462216831	232793	185	3125462327933	235841	95	3125462358418	237886	88	3125462378867
221687	66	3125462216879	232803	186	3125462328039	235913	95	3125462359132	237893	88	3125462378935
221859	77	3125462218590	232821	186	3125462328213	235921	95	3125462359217	237894	88	3125462378942
230123	180	3125462301230	232837	186	3125462328374	235927	95	3125462359279	237895	88	3125462378959
230133	180	3125462301339	232901	186	3125462329012	236243	96	3125462362439	237941	92	3125462379413
230141	180	3125462301414	232911	186	3125462329111	236251	96	3125462362514	237942	92	3125462379420
230313	180	3125462303135	232953	186	3125462329531	236257	96	3125462362576	237943	92	3125462379437
230323	180	3125462303234	232963	186	3125462329630	236285	96	3125462362859	237944	92	3125462379444
230349	180	3125462303494	233353	187	3125462333538	236373	96	3125462363733	237947	92	3125462379475
230453	180	3125462304538	233367	187	3125462333675	236381	96	3125462363818	237949	92	3125462379499
230461	180	3125462304613	233469	187	3125462334696	236387	96	3125462363870	240511	99	3125462405112
230573	180	3125462305733	233479	187	3125462334795	236398	96	3125462363986	240523	99	3125462405235
230591	180	3125462305917	233481	188	3125462334818	236400	91	3125462364006	240531	99	3125462405310
230603	181	3125462306037	233492	188	3125462334924	236401	91	3125462364013	240540	99	3125462405402
230611	181	3125462306112	233502	189	3125462335020	236403	97	3125462364037	240547	99	3125462405471
230613	181	3125462306136	233503	189	3125462335037	236411	97	3125462364112	240573	99	3125462405730
230619	181	3125462306198	233505	189	3125462335051	236413	97	3125462364136	240580	99	3125462405808
230723	181	3125462307232	233508	189	3125462335082	236421	97	3125462364211	240581	99	3125462405815
230731	181	3125462307317	233519	189	3125462335198	236463	91	3125462364631	240587	99	3125462405877
230843	181	3125462308437	233538	190	3125462335389	236474	91	3125462364747	241001	100	3125462410017



# Summary of references

Récapitulatif des références

Ref.	PAGE	EAN	Ref.	PAGE	EAN	Ref.	PAGE	EAN	Ref.	PAGE	EAN
241013	100	3125462410130	241880	16	3125462418808	250565	122	3125462505652	260626	128	3125462606267
241023	100	3125462410239	241975	47	3125462419751	250567	122	3125462505676	260649	117	3125462606496
241040	100	3125462410406	241983	47	3125462419836	250571	122	3125462505713	260721	118	3125462607219
241041	100	3125462410413	241991	47	3125462419911	250573	122	3125462505737	260723	118	3125462607233
241261	100	3125462412615	241993	47	3125462419935	250577	122	3125462505775	260727	118	3125462607271
241293	101	3125462412936	245115	113	3125462451157	250721	125	3125462507212	260821	119	3125462608216
241297	101	3125462412974	245209	113	3125462452093	250761	125	3125462507618	260929	119	3125462609299
241313	101	3125462413131	245443	116	3125462454431	250771	125	3125462507717	261023	119	3125462610233
241321	101	3125462413216	245457	116	3125462454578	250773	125	3125462507731	261031	119	3125462610318
241327	101	3125462413278	245465	116	3125462454653	250781	123	3125462507816	261122	106	3125462611223
241350	101	3125462413506	245695	116	3125462456954	250786	123	3125462507861	261137	106	3125462611377
241361	101	3125462413612	245760	114	3125462457609	250881	123	3125462508813	261140	106	3125462611407
241371	101	3125462413711	245795	114	3125462457951	250883	123	3125462508837	262015	81	3125462620157
241451	102	3125462414510	245801	114	3125462458019	250887	123	3125462508875	262024	81	3125462620249
241467	102	3125462414671	245803	114	3125462458033	250891	123	3125462508912	262036	82	3125462620362
241471	102	3125462414718	245821	114	3125462458217	250893	123	3125462508936	262041	82	3125462620416
241541	103	3125462415418	245823	114	3125462458231	250897	123	3125462508974	262046	83	3125462620461
241563	103	3125462415630	246051	115	3125462460517	251671	126	3125462516719	262048	83	3125462620485
241571	103	3125462415715	246063	115	3125462460630	251687	126	3125462516870	262049	85	3125462620492
241581	103	3125462415814	246077	115	3125462460777	252002	128	3125462520020	262100	85	3125462621000
241602	44	3125462416026	246088	115	3125462460883	252111	124	3125462521119	262171	84	3125462621710
241603	44	3125462416033	246751	111	3125462467516	253003	128	3125462530036	262180	84	3125462621802
241604	15	3125462416040	246763	111	3125462467639	253013	128	3125462530135	262185	84	3125462621857
241605	15	3125462416057	246777	111	3125462467776	260001	120	3125462600012	266015	138	3125462660153
241606	15	3125462416064	246941	111	3125462469411	260002	120	3125462600029	266127	138	3125462661273
241611	104	3125462416118	246953	111	3125462469534	260003	120	3125462600036	266246	139	3125462662461
241622	44	3125462416224	247023	112	3125462470233	260007	120	3125462600074	266396	139	3125462663963
241629	44	3125462416293	247031	112	3125462470318	260011	105	3125462600111	266401	140	3125462664014
241630	44	3125462416309	247032	112	3125462470325	260035	77	3125462600357	266503	140	3125462665035
241633	104	3125462416330	247037	112	3125462470370	260049	78	3125462600494	266768	119	3125462667688
241635	104	3125462416354	247045	112	3125462470455	260056	78	3125462600562	268849	142	3125462688492
241636	104	3125462416361	247153	112	3125462471537	260067	78	3125462600678	268861	144	3125462688614
241638	104	3125462416385	247161	112	3125462471612	260078	80	3125462600784	269146	84	3125462691461
241639	104	3125462416392	247162	112	3125462471629	260118	195	3125462601187	269324	85	3125462693243
241671	104	3125462416712	247167	112	3125462471674	260120	195	3125462601200	280041	148	3125462800412
241681	105	3125462416811	247315	115	3125462473159	260132	195	3125462601323	280054	148	3125462800542
241683	105	3125462416835	247325	115	3125462473258	260266	198	3125462602665	280133	148	3125462801334
241691	105	3125462416910	247652	121	3125462476525	260321	198	3125462603211	280141	148	3125462801419
241773	46	3125462417733	247761	121	3125462477614	260332	199	3125462603327	281168	148	3125462811685
241851	45	3125462418518	247763	121	3125462477638	260375	199	3125462603754	281381	148	3125462813818
241853	45	3125462418532	250553	122	3125462505539	260532	118	3125462605321	281492	148	3125462814921
241857	45	3125462418570	250554	122	3125462505546	260533	118	3125462605338	281503	149	3125462815034
241872	45	3125462418723	250555	122	3125462505553	260537	118	3125462605376	281836	149	3125462818363
241875	45	3125462418754	250556	122	3125462505560	260622	118	3125462606229	282027	149	3125462820274
241876	45	3125462418761	250557	122	3125462505577	260623	127	3125462606236	282039	149	3125462820397
241878	16	3125462418785	250561	122	3125462505614	260624	127	3125462606243	282049	149	3125462820496
241879	16	3125462418792	250562	122	3125462505621	260625	127	3125462606250	282171	149	3125462821714

# Summary of references

Récapitulatif des références

Ref.	PAGE	EAN	Ref.	PAGE	EAN	Ref.	PAGE	EAN	Ref.	PAGE	EAN
282841	150	3125462828416	302336	157	3125463023360	305590	160	3125463055903	320596	166	3125463205964
282852	150	3125462828522	302347	157	3125463023476	305944	160	3125463059444	320719	166	3125463207197
282963	149	3125462829635	302358	157	3125463023582	305955	160	3125463059550	321626	166	3125463216267
283396	150	3125462833960	302369	157	3125463023698	306340	161	3125463063403	330215	171	3125463302151
283884	149	3125462838842	302371	157	3125463023711	306351	161	3125463063519	330237	171	3125463302373
283895	149	3125462838958	302382	157	3125463023827	306359	161	3125463063595	330359	171	3125463303592
285196	152	3125462851964	302393	157	3125463023933	306362	161	3125463063625	330573	171	3125463305732
285531	152	3125462855313	302404	157	3125463024046	306473	161	3125463064738	330697	171	3125463306975
285664	151	3125462856648	302415	157	3125463024152	306574	161	3125463065742	330719	173	3125463307194
285678	151	3125462856785	302426	157	3125463024268	306796	161	3125463067968	330932	173	3125463309327
285831	151	3125462858314	302437	157	3125463024374	306929	162	3125463069290	331728	174	3125463317285
285953	151	3125462859533	302448	157	3125463024480	306930	162	3125463069306	331840	173	3125463318404
286230	151	3125462862304	302460	157	3125463024602	306941	162	3125463069412	331951	174	3125463319517
287372	152	3125462873720	302471	157	3125463024718	307002	162	3125463070029	331972	158	3125463319722
287594	152	3125462875946	302482	157	3125463024824	307013	162	3125463070135	335715	174	3125463357151
287605	152	3125462876059	302493	157	3125463024930	307124	162	3125463071248	335726	174	3125463357267
287838	152	3125462878381	302537	157	3125463025371	307346	162	3125463073464	335837	174	3125463358370
288525	153	3125462885259	302548	157	3125463025487	307350	162	3125463073501	336501	169	3125463365019
288636	153	3125462886362	302551	157	3125463025517	307902	162	3125463079022	336674	168	3125463366740
288760	153	3125462887604	302554	156	3125463025548	308136	163	3125463081360	336785	168	3125463367853
288869	154	3125462888694	302598	156	3125463025982	308147	163	3125463081476	336907	168	3125463369079
289203	153	3125462892035	302610	156	3125463026101	308470	164	3125463084705	337009	167	3125463370099
289204	202	3125462892042	302621	156	3125463026217	308482	164	3125463084828	337010	167	3125463370105
289205	202	3125462892059	302643	156	3125463026439	308692	164	3125463086921	337020	167	3125463370204
289206	202	3125462892066	303009	158	3125463030092	308702	164	3125463087027	337034	167	3125463370341
289214	153	3125462892141	303121	158	3125463031211	308713	164	3125463087133	337132	168	3125463371324
289325	153	3125462893254	303487	158	3125463034878	309007	164	3125463090072	337641	168	3125463376411
289658	154	3125462896583	303598	158	3125463035981	309129	164	3125463091291	337724	167	3125463377241
290604	154	3125462906046	303619	158	3125463036193	309420	169	3125463094209	340017	175	3125463400178
290615	154	3125462906152	303620	158	3125463036209	309431	169	3125463094315	340039	175	3125463400390
290637	154	3125462906374	303675	158	3125463036759	309442	169	3125463094421	340051	175	3125463400512
300014	155	3125463000149	303700	158	3125463037008	309453	169	3125463094537	340073	175	3125463400734
300147	155	3125463001474	303731	158	3125463037312	309464	169	3125463094643	340095	175	3125463400956
300369	155	3125463003690	303842	158	3125463038425	309475	170	3125463094759	340137	175	3125463401373
300370	155	3125463003706	303953	159	3125463039538	309486	170	3125463094865	340159	175	3125463401595
300382	155	3125463003829	304126	159	3125463041265	309497	170	3125463094971	340171	175	3125463401717
300481	155	3125463004819	304237	159	3125463042378	309509	170	3125463095091	340193	175	3125463401939
300825	157	3125463008251	304561	159	3125463045614	309610	163	3125463096104	340215	175	3125463402158
302195	156	3125463021953	304783	159	3125463047830	309721	163	3125463097217	340237	175	3125463402370
302257	157	3125463022578	304905	159	3125463049056	309732	163	3125463097323	341012	175	3125463410122
302268	157	3125463022684	304916	159	3125463049162	309765	165	3125463097651	341034	175	3125463410344
302279	157	3125463022790	304927	159	3125463049278	310012	170	3125463100122	341056	175	3125463410566
302281	157	3125463022813	304938	159	3125463049384	310034	170	3125463100344	341190	176	3125463411907
302292	157	3125463022929	305421	160	3125463054210	310078	170	3125463100788	341212	176	3125463412126
302303	157	3125463023032	305454	160	3125463054548	310089	170	3125463100894	341234	176	3125463412348
302314	157	3125463023148	305467	160	3125463054678	310127	163	3125463101273	341256	176	3125463412560
302325	157	3125463023254	305478	160	3125463054784	320486	165	3125463204868	342020	172	3125463420206

# Summary of references

Récapitulatif des références

Ref.	PAGE	EAN	Ref.	PAGE	EAN	Ref.	PAGE	EAN
342142	172	3125463421425	700051	206	3125467000510	713488	211	3125467134888
342164	172	3125463421647	700062	206	3125467000626	713517	211	3125467135175
342186	172	3125463421869	700073	206	3125467000732	714663	213	3125467146638
342208	172	3125463422088	700084	206	3125467000848	714685	213	3125467146850
342230	172	3125463422309	700095	206	3125467000954	714696	213	3125467146966
342252	172	3125463422521	700101	206	3125467001012	714828	213	3125467148281
342274	172	3125463422743	700223	207	3125467002231	715115	212	3125467151151
342296	172	3125463422965	700245	207	3125467002453	715137	212	3125467151373
346425	177	3125463464255	700267	207	3125467002675	715168	212	3125467151687
346436	177	3125463464361	700289	207	3125467002897	730367	214	3125467303673
346447	177	3125463464477	700335	207	3125467003351	730502	214	3125467305028
346458	177	3125463464583	700346	207	3125467003467	739499	217	3125467394992
346469	177	3125463464699	700379	207	3125467003795	739523	217	3125467395234
346470	177	3125463464705	700415	208	3125467004150	744342	214	3125467443423
346481	177	3125463464811	700448	208	3125467004488	744353	214	3125467443539
346492	177	3125463464927	700748	208	3125467007489	744495	214	3125467444956
346513	177	3125463465139	700759	208	3125467007595	744496	214	3125467444963
346524	177	3125463465245	700761	208	3125467007618	744497	215	3125467444970
346546	177	3125463465467	700783	208	3125467007830	744518	215	3125467445182
346568	177	3125463465689	703001	209	3125467030012	744529	215	3125467445298
346580	177	3125463465801	703012	209	3125467030128	744531	215	3125467445311
346591	177	3125463465917	703023	209	3125467030234	744603	215	3125467446035
346602	177	3125463466020	703034	209	3125467030340	744624	215	3125467446240
346613	177	3125463466136	703045	209	3125467030456	744626	215	3125467446264
346635	177	3125463466358	703059	209	3125467030593	745234	216	3125467452340
346657	177	3125463466570	703060	209	3125467030609	745367	216	3125467453675
346914	177	3125463469144	703072	209	3125467030722	745478	216	3125467454788
360301	204	3125463603012	703096	209	3125467030968	745480	216	3125467454801
360513	204	3125463605139	703107	209	3125467031071	745490	216	3125467454900
360535	204	3125463605351	703120	209	3125467031200	745498	217	3125467454986
365063	205	3125463650634	703186	209	3125467031866	745500	217	3125467455006
365074	205	3125463650740	703325	209	3125467033259	745501	217	3125467455013
365085	205	3125463650856	703336	209	3125467033365	745505	217	3125467455051
365096	205	3125463650962	705005	214	3125467050058	745510	217	3125467455105
380357	197	3125463803573	705027	214	3125467050270	756571	217	3125467565712
380358	197	3125463803580	705038	214	3125467050386	756591	217	3125467565910
380400	196	3125463804006	705263	210	3125467052632			
380401	196	3125463804013	705274	210	3125467052748			
380500	197	3125463805003	705285	210	3125467052854			
380501	197	3125463805010	705296	210	3125467052960			
380502	196	3125463805027	706426	210	3125467064260			
380503	196	3125463805034	710505	211	3125467105055			
390421	107	3125463904218	710507	211	3125467105079			
700017	205	3125467000176	710601	212	3125467106014			
700028	205	3125467000282	710612	212	3125467106120			
700039	205	3125467000398	712069	212	3125467120690			
700040	205	3125467000404	713475	211	3125467134758			

# Terms and conditions

FRANCE

## SALES

The commitments made by our sales are valid only after our acceptance. The terms of sale and the prices are those in effect on the date of issue of the order confirmation by us. If unable to provide fully or partially an order in an agreed period, it can be claimed for damages and interest. Exclusive sale to professionals of record trade or trades.

## ORDER

Due to the fixed costs associated with registration, preparation and shipping of all orders, orders for an amount less than € 150.00. HT (without tax) CASH will be taken in our store or dispatched with an interest invoice of 10.00 € without tax.

## EXPEDITION

FRANCO PORT AND PACKAGING, 510 € without tax.

Participation in the shipping cost for delivery below Franco :

Order less than 300 € net of tax : 10,00 €

Order of 300 € net of VAT to 510 € net of VAT : 20,00 €.

Export : Charges Starts from Warehouse

## TRANSPORT

In any case our shipments are carried out at the risks and perils of the recipient. Carriers are responsible for loss, damage or breakages.

The greatest care is given to the packaging, you must check the STATE OF GOODS on arrival, the carrier cannot impede the exercise of this right. A package may have no apparent trace of shock, and yet have been handled roughly. In case of damage, loss of packages or breakages, these must be the subject of precise reservations, if possible on the delivery note, confirmed by RECOMMENDED LETTER TO THE TRANSPORTER within 3 clear days of receipt. You may also request a quality agent to attend the verification

## RETURN

No return of goods can be done without our consent. When exceptional return is accepted, it must be sent free, accompanied by a statement of the number and the date of our invoice. Returned goods should come to us in the condition that we have provided. If there is a fault or an error on our part, we refund 80% of the invoice to cover the administrative expenses inherent in this process.

## PAYMENTS

### - EXPORT

Orders will be shipped against consignment documents or payment in advance upon quotation or "Pro Forma".

### - METROPOLIS

The first order is shipped against quotation or "Pro Forma". Special productions or orders will require down payments.

## DEADLINES

Upon transmission by the client of banking and commercial details enabling the creation of an account, payments are made as follow :

-For cash payment : the full amount is payable upon receipt of invoice.

-For delayed payments made within 30 days : payment by cheque, bank card or draft.

## RULES OF DELAY

All payments must be effectively received by our accounting services (Girard Sudron, service comptabilité, 10 rue Georges Sand, 41 200 ROMORANTIN

LANTHENAY) at the due date as stated on the invoice or statement. In accordance with Rule of Law No.2008-776 dated 04/08/ 2008 (as per the consolidated version of 01/01/2011), in case of non-payment on the date specified on the invoice, we reserve the right to require the payment of a penalty.

Under the terms of Décret No. 2012-1115 of 02 May 2012 for delays in payment (Art. D. 441-5) - the lump sum allowance payable for collection costs as stated in Art L 441-6, alinea 12 of | is a set amount of 40 €.

## CLAUSE AND EXPIRY OF TERM

The invoice payment can be made by credit card, payment slip or bank transfer in favour of the bank specified by us on our documents. Any order implies full acceptance to the buyer to the above conditions and the specific conditions of our specialized catalogues, regardless of the general conditions of purchase of our customers.

## CLAUSE OF PROPERTY

In accordance with the terms of Law No.80 335 of 12 May 1980 : upon express agreement, the products remain our property until the payment of the total purchase price is carried out in full.

## WARRANTY

If the product is damaged or an imperfection of any kind is found, we'll deliver a replacement product or we will propose a repair solution, once the damaged or defective product received by the company. It is recognized that only products used in the rules of the art, in accordance with current standards in the country of use, is equivalent to the minimum standards in the European Union, are covered by our warranty. (Excluding incandescent light sources or Eco-Halogen).

## EXCLUSIVE JURISDICTION

These conditions of sale and delivery are subject to French law "Courts of Paris".

# Conditions générales de vente

FRANCE

## VENTE

Exclusive aux professionnels inscrits aux Registres du Commerce ou des Métiers ou autres statuts et collectivités. Les engagements pris par nos commerciaux ne sont valables qu'après notre acceptation. Les conditions de vente et les prix sont ceux en vigueur à la date d'édition du tarif.

Dans l'impossibilité de fournir totalement ou partiellement une commande dans un délai convenu, il ne pourra être réclamé de dommages et intérêts.

## COMMANDE

En raison des frais fixes liés à l'enregistrement et la préparation, toute commande d'un montant inférieur à 150,00€ net H.T. fera l'objet d'une participation forfaitaire de 10,00€ hors TVA.

## EXPEDITION

- Métropole :

FRANCO port et emballage à partir de 510,00€ net H.T.

Participation au frais de port pour livraison inférieure au Franco :

Commande inférieure à 300 € net HT : 10,00 €

Commande de 300 € net HT à 510 € net HT : 20,00 €.

- Exportation : Facturation EXW

## TRANSPORT

Dans tous les cas nos expéditions sont réalisées aux risques et périls du destinataire. Les transporteurs sont seuls responsables des pertes, casses ou avaries.

Le plus grand soin étant apporté aux emballages, vous devez vérifier l'ETAT DES MARCHANDISES à leur arrivée, le transporteur ne peut faire obstacle à l'exercice de ce droit. Un colis peut ne pas avoir de traces apparentes de chocs, et cependant avoir été manipulé brutalement. En cas d'avaries, de perte de colis ou de casse, celles-ci doivent faire l'objet de réserves précises, si possible sur le bordereau de livraison, confirmées par LETTRE RECOMMANDEE AU TRANSPORTEUR dans les 3 jours francs suivant la réception. Vous pouvez aussi demander sur ce bordereau le passage d'un agent de qualité pour assister à la vérification.

## RETOUR

AUCUN RETOUR DE MARCHANDISES NE PEUT ETRE FAIT SANS NOTRE ACCORD. Lorsqu'exceptionnellement un retour est accepté, celui-ci doit nous parvenir franco, accompagné d'un document rappelant le numéro et la date de notre facture. Les marchandises retournées ne sont reprises que si elles nous parviennent dans l'état où nous les avons fournies. Cependant, sauf faute ou erreur de notre part, l'avoir se limitera à 80% du montant de la facture initiale pour couvrir les frais administratifs inhérents à cette opération.

## PAIEMENT

- EXPORT

Les commandes sont expédiées contre- documents ou sur devis payé d'avance.

- METROPOLE

La première commande est expédiée sur devis payé d'avance. Les fabrications et commandes spéciales donnent lieu à versement d'acomptes à la commande

## ECHÉANCES

Après communication des références bancaires et commerciales d'usage fournies par le client pour l'ouverture d'un compte les règlements s'effectuent :

- Pour un paiement comptant : A réception de facture pour la totalité du montant.

- Paiement à 30 jours nets, par virement, par chèque, CB, ou lettre-traité.

## RETARD DE RÈGLEMENT

Tout paiement doit être effectivement reçu par notre service comptabilité (Girard Sudron, service comptabilité, 10 rue Georges Sand, 41 200 ROMORANTIN LANTHENAY) à la date d'échéance mentionnée sur la facture ou le relevé. Conformément à la loi n°2008-776 du 4 août 2008 (version consolidée au 1er janvier 2011), en cas de non-paiement à la date stipulée sur la facture, nous nous réservons la possibilité d'exiger le paiement d'une pénalité.

Application du Décret n° 2012 -1115 du 2.10.12 pour les retards de paiement (Art. D. 441-5 – le montant de l'indemnité forfaitaire pour frais de recouvrement prévu au douzième alinéa du | de l'article L. 441-6 est fixé à 40 €.

## CLAUSE ET DÉCHÉANCE DU TERME

Le règlement de nos factures s'effectue par chèque bancaire, par traite, par carte ou virement au profit de la banque indiquée par nos services sur nos documents. Toute commande entraîne de plein droit adhésion de l'acheteur aux conditions ci-dessus et aux conditions particulières de nos catalogues spécialisés, quelles que soient les conditions générales d'achat de nos clients.

## CLAUSE DE RÉSERVE DE PROPRIÉTÉ

De convention expresse, les marchandises fournies resteront notre propriété jusqu'au dernier jour de leur parfait paiement, ceci, conformément aux termes de la loi n°80 335 du 12 mai 1980.

## GARANTIE

Si le produit est endommagé ou qu'une imperfection de quelque sorte que ce soit est constatée, nous vous livrerons un produit de remplacement, ou nous vous proposerons une solution de réparation ou établirons un avoir, une fois le produit endommagé ou défectueux réceptionné par la société. Il est admis que seuls les produits utilisés dans les règles de l'art, conformément aux normes en vigueur dans le pays d'utilisation, à minima équivalente aux normes applicables dans l'Union Européenne, sont couverts par notre garantie (hors sources lumineuses incandescence ou Eco-Halogène).

## JURIDICTION EXCLUSIVE

Ces conditions de vente et de livraison sont soumises au droit français. Tribunaux de Paris.

# Conditions générales de vente

SWITZERLAND

## VENTE

Les engagements pris par nos commerciaux ne sont valables qu'après notre acceptation.

Les conditions de vente et les prix sont ceux en vigueur à la date d'édition du présent barème.

Dans l'impossibilité de fournir totalement ou partiellement une commande dans un délai convenu, il ne pourra être réclamé de dommages et intérêts.

## COMMANDE

En raison des frais fixes liés à l'enregistrement, la préparation et l'expédition de toute commande, les ordres d'un montant inférieur à 100 francs suisses hors taxes pourront être pris au COMPTANT à notre magasin ou expédiés avec facturation d'une participation forfaitaire de 10 francs suisses hors taxes.

Pour toutes commandes contenant des produits nécessitant un emballage particulier sont susceptibles de faire l'objet d'une participation forfaitaire de 10 francs suisses hors taxes.

## EXPEDITION

Suisse : FRANCO PORT ET EMBALLAGE, au-dessus de 5'000 francs suisses hors taxes.

Exportation : FACTURATION DEPART ENTREPOT

## TRANSPORT

Dans tous les cas nos expéditions sont réalisées aux risques et périls du destinataire. Les transporteurs sont seuls responsables des pertes, casses ou avaries. Aucune réclamation ne peut être admise sur nos fournitures, si elle est effectuée plus de 3 jours après leur réception.

## AVARIES

Le plus grand soin étant apporté aux emballages, vous devez vérifier l'ETAT DES MARCHANDISES à leur arrivée, le transporteur ne peut faire obstacle à l'exercice de ce droit.

En cas d'avaries, celles-ci doivent faire l'objet de réserves précises, si possible sur le bordereau de livraison, confirmées par LETTRE RECOMMANDEE AU TRANSPORTEUR dans les 3 jours francs suivant la réception.

Vous pouvez aussi demander sur ce bordereau le passage d'un agent de qualité pour assister à la vérification.

## RETOUR

AUCUN RETOUR DE MARCHANDISES NE PEUT ETRE FAIT SANS NOTRE ACCORD. Lorsqu'exceptionnellement un retour est accepté, celui-ci doit nous parvenir franco, accompagné d'un document rappelant le numéro et la date de notre facture. Les marchandises retournées ne sont reprises que si elles nous parviennent dans l'état où nous les avons fournies.

Sauf omission ou erreur de notre part, l'avoir se limitera à 80% du montant de la facture initiale, pour couvrir les frais administratifs inhérents à cette opération.

## PAIEMENTS

Les commandes spéciales donnent lieu au versement d'un acompte à la commande.

**ECHEANCES** : Les règlements s'effectuent :

- Paiement à 30 jours nets, date de facture

Toutes nos conditions de paiement s'entendent date de départ, (les délais d'acheminement ne sont pas pris en compte) et toute dérogation éventuelle devra faire l'objet d'un accord écrit. Les escomptes sur facture pour paiement à réception ne sont pas acceptés, sauf en cas d'accord écrit préalable entre les deux parties.

## RETARD DE REGLEMENT

Tout paiement doit être effectivement reçu à NYON, dans l'entreprise Girard Sudron (Suisse) SA, à la date d'échéance mentionnée sur la facture ou le relevé. En cas de non-paiement à la date stipulée sur la facture, nous nous réservons la possibilité d'exiger le paiement d'une pénalité. Cette pénalité sera calculée en appliquant au montant total de la facture (frais accessoires et taxes compris) un taux équivalent à une fois et demi le taux d'intérêt légal en vigueur à la date du paiement notifiée sur la facture.

## CLAUSE ET ECHEANCE DU TERME

Le règlement de nos factures s'effectue par carte bancaire, par bulletin de versement ou par virement bancaire au profit de la banque indiquée sur nos documents officiels. Toute commande entraîne de plein droit adhésion de l'acheteur aux conditions ci-dessus et aux conditions particulières de nos catalogues spécialisés, quelles que soient les conditions générales d'achat de nos clients.

## CLAUSE DE RESERVE DE PROPRIETE

Le produit devient votre propriété dès que le paiement du prix d'achat total (frais de livraison inclus) a été effectué dans son intégralité. Nous sommes habilités à exiger à tout moment le renvoi des produits avant le transfert de propriété, si vous enfreignez les présentes conditions de vente et de livraison, et ceci à vos frais.

## GARANTIE

Si le produit est endommagé ou qu'une imperfection de quelque sorte que ce soit est constatée, nous vous livrerons un produit de remplacement, une fois le produit endommagé ou défectueux réceptionné par la société

(Hors sources lumineuses incandescence ou Eco-Halogène).

**JURIDICTION EXCLUSIVE** : For judiciaire et droit applicable.

For juridique et droit applicable. Dans la mesure où c'est légalement admissible, Nyon (Tribunal d'arrondissement de La Côte, Rue de Saint-Cergue 38, CH - 1260 Nyon) est le for juridique judiciaire exclusif pour tous les litiges liés à nos ces conditions de vente et de livraison. Girard Sudron (Suisse) SA est également habilitée à intenter une action juridique auprès de la juridiction compétente du domicile du client. Ces conditions de vente et de livraison sont soumises au droit suisse.

# Allgemeine Verkaufsbedingungen

SWITZERLAND

## VERKAUFE

Die von unseren Aussendienstmitarbeitern genommenen Verpflichtungen sind erst ab unserer Zustimmung gültig. Die geltenden Verkaufsbedingungen und Preise sind diese zum Zeitpunkt der Ausgabe der hiesigen Tabelle.

Bei Unmöglichkeit vollständig oder teilweise eine Bestellung in dem vereinbarten Zeitraum zu liefern, gibt es keinen Anspruch auf Schadensersatz.

## BESTELLUNG

Auf Grund der Kosten zur Eintragung, der Vorbereitung und dem Versand von jeglicher Bestellung, können Bestellungen unter einem Wert von 50 Schweizerische Franken ohne MwSt in unserem Geschäft genommen werden oder versendet mit einer pauschalen Beteiligung von 10 Schweizerische Franken ohne MwSt.

## VERSAND

Schweiz : Fracht und Verpackung bezahlt, ab einem Betrag von 5000.00 Schweizerische Franken ohne MwSt

Export : Fakturierung ab Lager

## TRANSPORT

In allen Fällen, trägt der Warenempfänger das Risiko des Versands. Die Spediteure sind alleinige Verantwortliche für Verlust, Bruch oder Schaden. Keine Reklamation kann auf unsere Ware angenommen werden, wenn sie 3 Tage nach dessen Erhalt durchgeführt wird.

## HAVARIE

Grösste Sorgfalt wird den Verpackungen geschenkt, sie müssen jedoch den ZUSTAND DER WAREN an Ihrer Ankunft prüfen, der Spediteur kann die Ausübung dieses Rechtes nicht verhindern.

Im Falle von Havarien, müssen diese ausdrücklich erwähnt werden, wenn möglich auf dem Lieferschein und dem per Einschreiben mit Rückschein dem Spediteur bestätigt innerhalb von 3 Werktagen nach Lieferung. Sie können auf diesem Lieferschein auch das Einschalten eines Fachmanns verlangen zur Teilnahme an der Warenprüfung.

## RÜCKNAHME

ES GIBT KEINE WARENRÜCKNAHME OHNE UNSER EINVERSTÄNDNIS. Wenn ausnahmsweise eine Rücknahme angenommen wird, muss diese uns portofrei zukommen, zusammen mit einem Dokument das Nummer und Datum der Rechnung erwähnt. Die zurückgeschickte Ware wird nur zurückgenommen, wenn wir sie in dem Zustand zurückerhalten wie wir sie auch geliefert haben.

Jedoch, ausser Fehler oder Irrtum unsererseits, beschränkt sich die Gutschrift auf 80% der Ursprungsrechnung um die Verwaltungskosten, die mit dieser Handlung verbunden sind, zu decken.

## ZAHLUNGEN

Sonderanfertigungen sind mit Anzahlungen bei der Auftragsstellung verbunden.

**ZAHLUNGSTERMINE** : Zahlungen erfolgen :

- Zahlung 30 Tagen netto, von den Rechnungsdatum

All unsere Zahlungsbedingungen verstehen sich Rechnungsdatum, (Beförderungsfristen werden nicht berücksichtigt) und jegliche Ausnahmebedarf der Schriftform. Skonto für Zahlung nach Erhalt wird nicht akzeptiert, wenn keine schriftliche Vereinbarung zwischen beide Parteien zustimmen.

## ZAHLUNGSVERSÄTUNG

Jede Zahlung muss tatsächlich in Nyon eingehen, in der Firma Girard Sudron (Suisse) SA, mit Fälligkeitsdatum auf der Rechnung oder der Aufstellung. Im Falle der Nichteinhaltung des auf der Rechnung festgelegten Zahlungsdatums, behalten wir uns vor, einen Säumnisszuschlag zu verlangen. Dieser Säumnisszuschlag wird berechnet, in dem man auf die Endsumme der Rechnung (samt Unkosten und Gebühren) einen Prozentsatz von eineinhalb Mal die gesetzlich geltende Rate zum Zeitpunkt des auf der Rechnung stehenden Zahlungsdatums ansetzt.

## KLAUSEL UND ZAHLUNGSFRIST

Die Begleichung unserer Rechnungen erfolgt durch Kreditkarte, durch Bankeinzug, oder durch Überweisung zum Gunsten der durch unsere Abteilungen angegebenen Bank. Durch jede Bestellung tritt der Verkäufer kraft Gesetzes zu unseren Verkaufsbedingungen und in unseren Spezial Katalogen stehenden Sonderbedingungen bei, was auch immer die Einkaufsbedingungen unserer Kunden sein mögen.

## EIGENTUMSVORBERHALTSKLAUSEL

Der Eigentumsübergang erfolgt, sobald der vollständige Kaufpreis (Lieferungskosten einbegriffen) bezahlt wurde. Wir sind zu jederzeit verfügt vor Eigentumsübergang die Rücksendung der Produkte zu verlangen, wenn Sie gegen die hiesigen Verkaufsbedingungen und Lieferbedingungen verstossen, und alles auf Ihre Kosten.

## ALLEINIGE GERICHTSBARKEIT

Gerichtsstand und anwendbares Recht. Insoweit es rechtlich vertretbar ist, ist Nyon (Tribunal d'arrondissement de la Côte, rue de Saint Cergues 38, CH -1260 Nyon) die ausschliessliche Gerichtsbarkeit für jeglichen Rechtsstreit betreffend unsere diese Verkaufsbedingungen und Lieferbedingungen. Girard Sudron (Suisse) SA Ecolight Services ist ebenfalls berechtigt um einen Rechtsstreit an der zuständigen Gerichtsbarkeit des Wohnsitzes des Kunden einzugehen. Diese Verkaufsbedingungen und Lieferbedingungen sind dem Schweizer Recht unterworfen.

# Allgemeine verkaufsbedingungen

DEUTSCHLAND

## VERKAUF

Die von unseren Aussendienstmitarbeitern erhaltenen Bestellungen sind erst mit unserer Zustimmung gültig. Basis fuer die Abwicklung sind die zu diesem Zeitpunkt geltenden Verkaufsbedingungen und Preislisten.

Bei Unmöglichkeit der Lieferung – ob vollständig oder teilweise im vereinbarten Zeitraum, gibt es keinen Anspruch auf Schadensersatz.

## BESTELLUNG

Auf Grund der Kosten zur Vorbereitung, Bearbeitung und dem Versand von Bestellungen, beträgt der Mindestauftragswert 150 EURO (Netto-Warenwert). Darunterliegende Auftragswerte erfordern eine Bearbeitungspauschale von 19,95 EURO.

## VERSAND

Deutschland : Frachtfreie Lieferung ab einem Netto-Auftragswert von 400 EURO ohne MwSt.

## TRANSPORT

In allen Fällen, trägt der Warenempfänger das Risiko des Versands. Die Spediteure sind allein Verantwortliche für Verlust, Bruch oder Schaden. Reklamationen koennen nur beruecksichtigt werden, wenn sie spätestens 3 Tage nach dessen Erhalt angezeigt werden.

## HAVARIE

Wir legen grösste Sorgfalt bei unseren Verpackungen zugrunde. Die Ware ist jedoch direkt nach Erhalt zu ueberpruefen. Der Spediteur kann die Ausübung dieses Rechtes nicht verhindern.

Im Falle von Transportschäden, müssen diese ausdrücklich auf dem Lieferschein oder Frachtbrief erwähnt werden.

## RÜCKNAHME

ES GIBT KEINE WARENÜCKNAHME OHNE UNSERE ZUSTIMMUNG. Wenn ausnahmsweise eine Rücknahme angenommen wird, muss diese portofrei an uns zurueckgesendet werden, zusammen mit einem Dokument das Nummer und Datum der Rechnung erhält. Die zurückgeschickte Ware wird nur zurückgenommen, wenn wir sie in dem Zustand zurückerhalten wie wir sie auch geliefert haben.

Jedoch, ausser Fehler oder Irrtum unsererseits, beschränkt sich die Gutschrift auf 80% der Ursprungsrechnung um die Verwaltungskosten, die mit dieser Handlung verbunden sind, zu decken.

## ZAHLUNGEN

Sonderanfertigungen sind mit Anzahlungen bei der Auftragerstellung verbunden.

## ZAHLUNGSBEDINGUNGEN

- Zahlung 30 Tagen netto ab Rechnungsdatum

All unsere Zahlungsbedingungen verstehen sich ab dem Rechnungsdatum, (Beförderungsfristen werden nicht berücksichtigt) und jegliche Ausnahme bedarf der Schriftform. Skonto für Zahlung nach Erhalt werden nicht akzeptiert, wenn keine schriftliche Vereinbarung zwischen beiden Parteien vorliegt.

## ZAHLUNGSVERSÄTUNG

Jede Zahlung muss fristgerecht auf unserem Konto eingehen.

Im Falle der Nichteinhaltung des auf der Rechnung festgelegten Zahlungsdatums, behalten wir uns vor, einen Säumnisszuschlag zu erheben. Dieser Säumnisszuschlag wird berechnet, in dem man auf die Endsumme der Rechnung (samt Kosten und Gebühren) einen Prozentsatz von eineinhalb Mal die gesetzlich geltende Rate zum Zeitpunkt des auf der Rechnung stehenden Zahlungsdatums ansetzt.

## KLAUSEL UND ZAHLUNGSFRIST

Die Begleichung unserer Rechnungen erfolgt durch Kreditkarte, durch Bankeinzug, oder durch Überweisung zu Gunsten der durch unsere Abteilungen angegebenen Bank. Durch jede Bestellung stimmt der Verkäufer unseren Verkaufsbedingungen und in unseren Spezial Katalogen stehenden Sonderbedingungen zu, unabhängig von Kunden-Einkaufsbedingungen.

## EIGENTUMSVORBERHALTSKLAUSEL

Der Eigentumsübergang erfolgt, sobald der vollständige Kaufpreis (Lieferungskosten einbegriffen) bezahlt wurde. Wir sind zu jederzeit berechtigt vor Eigentumsübergang die Rücksendung der Produkte zu verlangen, wenn Sie gegen die hiesigen Verkaufsbedingungen und Lieferbedingungen verstossen. Die Kosten hierfuer trägt der Käufer.

## ALLEINIGE GERICHTSBARKEIT

Gerichtsstand und anwendbares Recht.

Gerichtsstand ist Hermeskeil für jeglichen Rechtsstreit bezüglich unserer Verkaufs- und Lieferbedingungen. Diese Verkaufsbedingungen und Lieferbedingungen unterliegen dem deutschen Recht.



Art. 1) Conclusione del contratto e rapporti con i rappresentanti commerciali - Le offerte fatte da agenti, rappresentanti ed ausiliari di commercio di Lighting Diffusion S.r.l., e qualsivoglia altro impegno assunto dai medesimi, non produrranno effetto nei confronti di Lighting Diffusion S.r.l., se non previa nostra accettazione dell'ordine, che dovrà avvenire per iscritto e comunicata alla parte acquirente. Solo a seguito di tale accettazione il contratto di compravendita si intenderà concluso.

Le offerte di vendita formulate da agenti, rappresentanti ed ausiliari di commercio di Lighting Diffusion S.r.l. hanno una validità di 30 giorni decorrenti dalla formulazione delle stesse e limitatamente all'integrale fornitura di quanto in esse definito.

Decorso il suddetto termine l'offerta di vendita non avrà più alcuna validità.

Art. 2) Normativa applicabile alle presenti Condizioni Generali di vendita ed al contratto di vendita - Alle presenti Condizioni Generali si applica la normativa italiana. Al contratto di compravendita si applicano le presenti Condizioni Generali di vendita e la normativa italiana per quanto non espressamente disciplinato dalle presenti Condizioni Generali. Tutti gli ordini eseguiti da parte acquirente costituiscono adesione alle presenti Condizioni Generali. Le presenti Condizioni Generali disciplinano tutti i rapporti di fornitura fra le parti e saranno applicabili anche in caso di deroghe alle stesse concordate per iscritto per le parti non espressamente derogate. Eventuali condizioni generali d'acquisto redatte dall'Acquirente non troveranno applicazione nei rapporti fra le parti se non espressamente accettate per iscritto da Lighting Diffusion S.r.l. ed in ogni caso non invalideranno l'efficacia delle presenti Condizioni Generali, con cui dovranno essere coordinate.

Art. 3) Dati tecnici e documenti inerenti alla fornitura - I pesi, le dimensioni, i prezzi, i rendimenti, i colori e gli altri dati relativi ai prodotti forniti ed indicati nei cataloghi, nei listini o in altri documenti illustrativi, redatti da Lighting Diffusion S.r.l., così come le caratteristiche dei campioni, hanno carattere meramente indicativo e non hanno natura vincolante, salvo vengano indicati come tali nell'offerta di vendita o nella conferma d'ordine.

Lighting Diffusion S.r.l. si riserva il diritto di modificare in qualunque momento i particolari costruttivi dei propri prodotti al fine di migliorarne le prestazioni, previa comunicazione all'Acquirente qualora si tratti di variazioni sostanziali.

Art. 4) Prezzi - I prezzi dei prodotti si riferiscono al listino prezzi in vigore al momento della offerta di vendita o conferma d'ordine da parte di Lighting Diffusion S.r.l. Lighting Diffusion S.r.l. si riserva il diritto di modificare in ogni momento il listino prezzi in vigore.

Art. 5) Pagamenti - I pagamenti dovranno essere effettuati in conformità alle indicazioni contenute nell'offerta di vendita o nella conferma d'ordine. I pagamenti ed ogni altra somma dovuta a qualsiasi titolo a Lighting Diffusion S.r.l. devono essere effettuati con carta di credito, assegno bancario, bollettino postale o bonifico a favore della banca indicata nella documentazione inerente il contratto di competenza.

Eventuali pagamenti fatti ad agenti, rappresentanti o ausiliari di commercio di Lighting Diffusion S.r.l. non liberano l'acquirente dalla sua obbligazione, finché le relative somme non pervengono alla parte venditrice.

Salvo patto contrario, i pagamenti verranno effettuati in Euro.

Art. 6) Ritardo o irregolarità del pagamento - Qualsiasi ritardo o irregolarità nei pagamenti attribuisce a Lighting Diffusion S.r.l. il diritto di :

a) sospendere le forniture in corso, anche se non relative al pagamento in questione, sino alla regolarizzazione del pagamento;

b) variare le modalità di pagamento e di sconto per le forniture successive, anche richiedendo al pagamento anticipato il rilascio di apposite garanzie.

L'Acquirente sarà tenuto al pagamento integrale dei prodotti anche nel caso in cui sorgano eccezioni, contestazioni o controversie che verranno definite solo successivamente alla corresponsione di quanto dovuto.

Art. 7) Spedizione e trasporto delle merci - Lighting Diffusion S.r.l. una volta comunicata l'accettazione scritta dell'ordine come disciplinata all'Art. 1), provvederà ad incaricare il vettore (soggetto terzo) del trasporto delle merci.

Il trasporto verrà effettuato sino al luogo di destinazione indicato dalla parte acquirente.

Le spese del trasporto saranno interamente a carico della parte acquirente al momento dell'ordine.

Lighting Diffusion S.r.l. si libererà dall'obbligo di consegna delle merci, e da ogni rischio connesso al trasporto, nel momento in cui le merci stesse verranno consegnate al vettore.

Art. 8) Spese di imballaggio - Le spese di imballaggio saranno a carico della parte acquirente per ordini di valore inferiore ad Euro 5.000,00.

Art. 9) Fatturazione - Lighting Diffusion S.r.l. provvederà alla fatturazione al momento della consegna al vettore della merce oggetto di compravendita. La fattura verrà consegnata dal vettore stesso il quale provvederà a sua volta a consegnarla a parte acquirente. Le fatture s'intendono integralmente accettate ove non siano respinte entro dieci giorni dal loro ricevimento. Tale invio potrà avvenire anche con mezzi telematici.

Art. 10) Termini di consegna - I termini di consegna hanno meramente valore indicativo : è esclusa ogni responsabilità di Lighting Diffusion S.r.l. per eventuali danni derivanti da anticipata o ritardata consegna, totale o parziale.

Art. 11) Impossibilità totale o parziale di evadere l'ordine - L'impossibilità o incapacità totale o parziale da parte di Lighting Diffusion S.r.l. di evadere un ordine nei termini concordati, anche per mancanza di scorte di magazzino, non potrà essere causa di richiesta di risarcimento danni e di interessi.

Art. 12) Norme tecniche e responsabilità - I prodotti Lighting Diffusion S.r.l. sono conformi alla legislazione e alle norme tecniche vigenti in Italia, conseguentemente l'Acquirente si assume la responsabilità di verificare ogni eventuale difformità esistente tra le norme italiane e quelle del paese di destinazione dei prodotti, tenendo indenne Lighting Diffusion S.r.l.

Lighting Diffusion S.r.l. garantisce le prestazioni dei prodotti di sua fornitura solo ed esclusivamente in relazione ad usi, destinazioni, applicazioni, tolleranze, ecc. espressamente indicati da essa o nelle istruzioni d'uso dei beni medesimi.

Art. 13) Denuncia vizi e difetti della merce - Parte acquirente avrà il diritto ed onere di verificare lo stato degli imballaggi e della merce ricevuta.

I vizi e difetti della merci, che non sia possibile riconoscere già al momento della consegna, dovranno essere denunciati a parte venditrice a pena di decadenza entro otto giorni dal loro ricevimento a mezzo raccomandata a.r., indicando dettagliatamente i vizi o le non conformità riscontrate.

I vizi e difetti delle merci che sia possibile riconoscere già al momento

# Condizioni generali di vendita

ITALY

della consegna, ed in particolare quelli riconoscibili già negli imballaggi e che potrebbero essere riconducibili ad imperizia del vettore, dovranno essere denunciati immediatamente alla venditrice, mediante contestazione effettuata al vettore e riportata sul documento di consegna ed altresì inviando a parte venditrice comunicazione scritta a mezzo raccomandata a.r., indicando dettagliatamente i vizi o le non conformità riscontrate.

In seguito alla regolare denuncia dell'Acquirente, effettuata secondo le modalità di cui sopra, Lighting Diffusion S.r.l., a sua scelta e – salvo diverso accordo – a sue spese, potrà : a) riparare i prodotti difettosi; b) fornire gratuitamente presso la sede dell'Acquirente prodotti dello stesso genere e quantità di quelli risultati difettosi; c) emettere nota di credito in favore dell'Acquirente per una somma pari al valore dei prodotti resi, come indicato in fattura. In tali casi Lighting Diffusion S.r.l. avrà il diritto di richiedere ed ottenere la resa dei prodotti difettosi, che diventeranno di sua proprietà.

L'Acquirente decade dal diritto di garanzia se non consente ogni ragionevole controllo richiesto da Lighting Diffusion S.r.l. o qualora non provveda a restituire i prodotti difettosi entro 10 giorni dalla relativa richiesta, che avverrà per iscritto.

Esclusivamente i prodotti conservati e/o utilizzati alla regola dell'arte, ed in conformità alle istruzioni fornite con i prodotti stessi, alle norme in vigore nel Paese di utilizzo, ed in ogni caso quantomeno secondo la normativa dell'Unione Europea, sono coperti dalla nostra garanzia.

Nell'eventualità in cui i difetti riscontrati sui prodotti non risultino ascrivibili alla responsabilità di Lighting Diffusion S.r.l., le spese di riparazione e/o sostituzione dei prodotti saranno conteggiate e fatturate all'Acquirente.

Art. 14) Risarcimento danni - La responsabilità di Lighting Diffusion S.r.l., contrattuale, extracontrattuale o oggettiva, non potrà in ogni caso eccedere il valore del prodotto a cui tale responsabilità si ricollega. Lighting Diffusion S.r.l. non sarà responsabile per mancato guadagno o perdita di profitto o per qualsiasi eventuale altro danno anche indiretto o consequenziale, per reclami provenienti dall'Acquirente e/o da terzi.

Art. 15) Restituzione della merce - La restituzione della merce potrà avvenire esclusivamente previo assenso scritto di Lighting Diffusion S.r.l. In caso di accettazione alla restituzione nei termini di cui sopra, la stessa dovrà avvenire Franco Nostro Magazzino, munita di idoneo imballaggio, e nel documento di trasporto dovrà essere descritta la merce, indicata la relativa quantità ed indicato il numero e la data della nostra fattura.

Art. 16) Divieto di cessione del contratto - E' fatto divieto a parte acquirente di cedere o trasferire, in qualunque forma, il rapporto contrattuale senza il preventivo consenso scritto di Lighting Diffusion S.r.l.

Art. 17) Foro competente - Qualsiasi controversia che dovesse insorgere tra le parti, anche in relazione alla stipulazione, validità, interpretazione, esecuzione, risoluzione o inadempimento del presente contratto sarà di competenza esclusiva del Tribunale di Padova.

Art. 18) Modifica e Aggiornamento - Lighting Diffusion S.r.l. può apportare modifiche o emendamenti alle presenti Condizioni Generali in qualsiasi momento. Pertanto, sarà richiesto al Cliente di accettare esclusivamente le Condizioni Generali in vigore al momento del relativo acquisto. Tali modifiche o emendamenti potranno essere comunicate/i per iscritto alla parte acquirente.

Art. 19) Protezione dei dati personali - dati personali dell'Acquirente saranno trattati secondo quanto disposto dalla legge Italiana in materia di trattamento dei dati personali (Decreto Legislativo n. 196/2003). Lighting Diffusion S.r.l. informa l'Acquirente che il Venditore è il titolare del trattamento e che i dati personali dell'Acquirente vengono raccolti e trattati esclusivamente per l'esecuzione del contratto. Ai sensi dell'articolo 7 del D. Lgs. n. 196/2003, l'Acquirente ha il diritto di richiedere al Venditore l'aggiornamento, la rettifica, l'integrazione, la cancellazione e la trasformazione in forma anonima dei propri dati.

# Terms and conditions

UNITED KINGDOM

## 1) DEFINITIONS

**a)** The “Goods” and/or the “Services” means the articles or things, or the facilities or any of them described in the Contract.

**b)** The “Buyer” means the person, firm or company with whom the contract is made by the Company for the sale of the Goods or supply of Services.

**c)** The “Contract” means these Conditions of Sale, the Buyer’s order for the Goods or Services and the Company’s acknowledgement of order (if any), and if there is any inconsistency between the documents comprising the Contract or with the terms of any order, letter or form of contract sent by the Buyer, whatever their respective dates, these conditions will prevail except where the Company has expressly agreed otherwise in writing.

## 2) ORDERS

**a)** These Conditions are deemed to be incorporated in all contracts of the Company with the Buyer.

**b)** Acceptance of the Buyer’s order is subject to supplies being available and unsold and is only effective where the Company has confirmed acceptance of the order in writing in the Company’s usual form or such other form as may have been expressly agreed by the Company.

## 3) RISK AND TITLE TO GOODS

**a)** Risk in the Goods shall pass to the Buyer on delivery and the Buyer shall keep the Goods insured in the full replacement value thereof against all insurable risk.

**b)** The Goods remain the property of the Company until payment is made on all sums due, (including any default interest), under (a) all contracts between the Buyer and the Company, whether or not the same are immediately due and payable, and (b) all contracts between the Company and the Buyer.

**c)** Before title passes under these conditions:

**i)** The Buyer shall hold the Goods as fiduciary agent and bailee of the Company and shall at its own expense keep the Goods safe and secure and take all reasonable steps to maintain the value of the Goods and store the same so that they are readily identifiable as the Company’s Goods.

**ii)** The Buyer may not re-sell or otherwise alienate the Goods.

**iii)** The Company may enter upon any premises of the Buyer at any time in order to recover the Company’s Goods, and the Buyer will allow or procure the Company or its employees or agents access to any premises in which the Goods are situated to recover the Goods. The Company shall have the right to re-sell such Goods in addition to any power of sale arising by operation of law or otherwise.

## 4) DELIVERY

**a)** Unless otherwise agreed by the Company and the Buyer in writing, the Company shall deliver the Goods to the Buyer at the Buyer’s premises.

**b)** All dates given for delivery of the Goods are given in good faith but without responsibility on the part of the Company. Time of delivery shall not be of the essence for the purposes of the Contract. In particular but without limitation the Company shall not be liable for any delay beyond the reasonable control of the Company and the Buyer will not be entitled to cancel the Contract or any other contract with the Company or make any claim against the Company by reason of the Company’s or its agents failure to meet a stated delivery time.

**c)** Goods or Services may be supplied by instalments, and if the delivery of the Goods or performance of Services is made by instalments, the Company may invoice each instalment separately and may suspend delivery or performance of further instalments, until the purchase price of all Goods or Services under the Contract, has been received in full by the Company.

**d)** The Buyer agrees to take delivery of Goods or Services on the stated delivery date(s) (or such alternative date(s) as may be agreed with the Company) and will reimburse the Company in full for any costs and expenses incurred by the Company if delivery fails as a result of the Buyer’s act or omission.

## 5) PRICE AND PAYMENT

**a)** All prices quoted by the Company are ex-works and are exclusive of VAT unless otherwise stated.

**b)** The price for Goods or Services will be that applicable on the date of issue of invoice and excludes carriage unless otherwise stated.

**c)** Payment for Goods or Services shall be due by the terms agreed on your account in cleared funds without deduction set off or counter claim

**d)** If Buyer fails to pay in accordance with the Contract, the Company may, without prejudice to any other right or remedy available to it, do any of the following:

**i)** Suspend all further deliveries and/or the performance of any Services without notice to the Buyer;

**ii)** Charge interest on any outstanding amount at the maximum statutory rate;

**iii)** Serve notice on the Buyer to make immediate payment for all Goods or Services supplied or contracted to be supplied under this or any other contract with the Buyer, whether or not such payment would otherwise be due;

**iv)** Sue for the price of Goods and/or Services even if in the case of Goods title may not have passed to the Buyer.

**e)** The Company reserves the right to refuse or withdraw credit facilities at any time.

## 6) SPECIFICATION, DAMAGE, SHORTAGE OR LOSS

**a)** The information contained in marketing, sales and/or technical literature relating to Goods and Services is for guidance and shall not form part of the Contract. The Company reserves the right to alter the dimensions, design or appearance of the Goods or the personnel or method of delivery of the Services from time to time to comply with applicable standards, test results, laws or for any other reason and will use all reasonable efforts to advise Buyer of any actual or proposed changes. Such changes will not entitle to Buyer to cancel the Contract or any delivery or give rise to any claim against the Company;

**b)** Claims for non-delivery must be notified to the Company immediately on receipt of invoice. The Buyer shall be deemed to have inspected the Goods on delivery and must notify any damage or shortage to the Company in writing promptly following delivery. Any damage which is not apparent by inspection must be notified to the Company immediately it is discovered and the Buyer will not alter, amend or otherwise deal with any Goods so affected until and unless the Company has had the opportunity to inspect the affected Goods and agreed that the Buyer may do so Goods returned to the Company without the Company’s prior written consent will not be accepted for credit.

# Terms and conditions

UNITED KINGDOM

**c)** If the Buyer does not give notice in accordance with the Contract, the Goods shall be deemed to conform and be delivered in all respects in accordance with the Contract and the Buyer shall be deemed to have accepted the Goods.

## 7) EXCLUSION OF LIABILITY

**a)** The Company shall not be liable for loss or damage to Goods by reason of

**i)** Fair wear and tear,

**ii)** The Buyer's attempting to repair or alter Goods without the Company's consent, or

**iii)** The storage or handling of the Goods by the Buyer.

**b)** The Company shall not be liable for death or personal injury except where attributable to the Company's failure to exercise reasonable care.

**c)** The Company shall not be liable for any special or indirect loss, loss of profit or consequential loss of the Buyer. Where Goods or Services are supplied for the purpose of a business, the Company's liability (save in respect of death or personal injury as aforesaid) is limited to the price of the Goods or Services giving rise to the claim.

**d)** The Company shall not be liable for any failure to perform by reason of events outside its control.

## 8) CANCELLATION

**a)** Cancellation by the Buyer must be made in writing and received at least 14 working days before the given date of delivery of the Goods or supply of the Services. The Buyer will pay any additional costs and expenses of the Company resulting from cancellation.

## 9) GENERAL

**a)** The Buyer may not assign the benefit of this Contract without the Company's prior written consent. The Company may assign or sub-contract the whole or any part of the Contract.

**b)** The invalidity or unenforceability of any of these conditions shall not affect the remaining conditions, which shall remain in full force and effect and where appropriate the invalid or unenforceable provision shall be replaced by a valid provision corresponding as far as possible with the void provision.

**c)** Waiver, delay or failure to exercise any right or remedy by the Company will not affect its ability to exercise such right or any other right, nor will the exercise of any such right or remedy prevent any further exercise of that or any other right or remedy by the Company.

**d)** Third party rights which may otherwise arise under the Contracts (Rights of Third Parties) Act 1999 or any replacement are excluded under the Contract.

**e)** The Contract shall in all respects be governed by English Law and the Buyer submits for the Company's benefit to the jurisdiction of the English Courts.

**f)** Nothing in this Contract shall affect the statutory rights of any consumer.

## 10) USE OF PERSONAL INFORMATION

Notice to individual Buyers and/or directors of Buyers

**a)** "Personal Information" means personal information relating to an individual which is supplied to the Company by the said individual in connection with an application to open an account with the Company on behalf of a Buyer or which is supplied to or lawfully obtained by the Company at any other time or which it learns from the operation of the Buyer's account and the products and services purchased by that Buyer from the Company.

**b)** The Company will use your Personal Information to make enquiries with credit reference agencies which will retain a record of such enquiry and may share such information with other organizations for credit assessments, assess availability of credit insurance and to prevent fraud.

**c)** The Company may also monitor and record information relating to your trade credit record and may make such information available to other organisations to assess applications for credit. **d)** The Company may process your Personal Information for the following purposes:

**i)** To enable the Company to contact you in respect of telephone enquiries and orders

**ii)** To help in the administration of your account

**iii)** To help detect fraud

**iv)** To keep you informed by letter, telephone or other form of communication of other products and services offered by Girard Sudron UK LTD.

IF YOU DO NOT WISH YOUR DATA TO BE HELD OR PROCESSED FOR THE PURPOSE SET OUT IN THIS PARAGRAPH (d), PLEASE WRITE TO THE CREDIT CONTROL DEPARTMENT AT GIRARD SUDRON UK LTD, UNIT 13 BENTLEY COURT, FINEDON IND EST, WELLINGBOROUGH, NORTHAMPTONSHIRE NN8 4BQ.

# Conditions générales de vente

BELGIUM

## VENTE

Exclusive aux entreprises, professions libérales et entités publiques et à l'exclusion des consommateurs. Les engagements pris par nos représentants commerciaux ne sont valables qu'après acceptation formelle par un représentant officiel de notre société. Les conditions de vente et les prix sont ceux en vigueur à la date d'édition du tarif.

Toute commande entraîne, de plein droit, adhésion de l'acheteur aux présentes conditions et aux conditions particulières de nos catalogues spécialisés, quelles que soient les conditions générales d'achat de nos clients. Les éventuelles conditions générales d'achat du client sont expressément exclues du champ contractuel.

## COMMANDE

En raison des frais fixes liés à l'enregistrement et la préparation, toute commande d'un montant inférieur à 150,00 € net H.T. fera l'objet d'une participation forfaitaire de 10,00 € hors TVA.

## EXPÉDITION ET LIVRAISON

Application des Incoterms 2010 : EXW Romorantin-Lanthenay (France).

Les délais de livraison sont communiqués à titre indicatif uniquement. Nous nous efforçons toutefois de les tenir mais en aucun cas, ils ne constituent un engagement ferme. Dans l'impossibilité de fournir totalement ou partiellement une commande dans un délai convenu, il ne pourra être réclamé de dommages et intérêts.

## TRANSPORT

Dans tous les cas, nos expéditions sont réalisées aux risques et périls du destinataire. Les transporteurs sont seuls responsables des pertes, casses ou avaries.

Le plus grand soin étant apporté aux emballages, le destinataire doit vérifier l'état des marchandises à leur arrivée, le transporteur ne pouvant faire obstacle à l'exercice de ce droit. Un colis peut ne pas comporter de traces apparentes de chocs, mais avoir cependant été manipulé brutalement. Tout cas d'avarie, de perte de colis ou de casse, doit faire l'objet de réserves précises, si possible sur le bordereau de livraison et doit être confirmé par lettre recommandée au transporteur, dans les 3 jours francs suivant la réception. Le destinataire peut aussi demander, via le bordereau de livraison, le passage d'un agent de qualité pour assister à la vérification.

## RETOUR

Aucun retour de marchandises ne peut être fait sans notre accord. Lorsqu'exceptionnellement un retour est accepté, celui-ci doit nous parvenir franco, accompagné d'un document rappelant le numéro et la date de notre facture. Les marchandises retournées ne sont reprises que si elles nous parviennent dans l'état où nous les avons fournies. Cependant, sauf faute ou erreur de notre part, nous ne rembourserons que 80% du montant de la facture initiale, les 20% restants étant destinés à couvrir les frais administratifs inhérents à cette opération.

## PAIEMENT

Les commandes sont expédiées après remise documentaire ou crédit documentaire ou sur devis payé d'avance. Le règlement de nos factures s'effectue par traite, par carte bancaire ou virement au profit de la banque indiquée par nos services sur nos documents. Les frais bancaires sont à charge du client.

## ÉCHÉANCES

Après communication des références bancaires et commerciales d'usage fournies par le client pour l'ouverture d'un compte les règlements s'effectuent :

- Pour un paiement comptant : A réception de facture pour la totalité du montant.
- Paiement à 30 jours nets, par virement, carte bancaire, ou lettre-traité.

## RETARD DE RÈGLEMENT

Tout paiement doit être effectivement reçu par notre service comptabilité à la date d'échéance mentionnée sur la facture ou le relevé. En cas de non-paiement à la date stipulée sur la facture, le client est redevable, sans mise en demeure préalable, du paiement d'intérêts de retard conformément à la loi du 2 août 2002 concernant la lutte contre le retard de paiement dans les transactions commerciales et d'une pénalité forfaitaire équivalent à 15% du montant de la facture impayée avec un minimum de 40€.

Le défaut de paiement d'une livraison nous autorise à suspendre les expéditions et rend exigible la valeur des produits commandés, disponibles ou en cours de fabrication. Le défaut de paiement provoque également la déchéance du terme et rend immédiatement exigible toutes les autres créances.

Ne constitue pas des paiements, la remise de traites ou de tous titres créant une obligation de payer.

## CLAUSE DE RÉSERVE DE PROPRIÉTÉ

De convention expresse, les marchandises fournies resteront notre propriété jusqu'au jour de leur parfait paiement, ceci, conformément aux termes des articles 69 et suivants du Livre III, Titre XVII du Code Civil belge. En conséquence, en cas de non-paiement, la société est en droit d'effectuer ou de faire effectuer la reprise de la marchandise à la charge du destinataire.

## GARANTIE ET RESPONSABILITÉ

Si le produit est endommagé ou qu'une imperfection de quelque sorte que ce soit est constatée, nous livrerons un produit de remplacement, proposerons une solution de réparation, ou établirons un avoir, après réception du produit endommagé ou défectueux renvoyé par la société, et ce dans un délai normal. Il est admis que seuls les produits utilisés dans les règles de l'art, conformément aux normes en vigueur dans le pays d'utilisation, à minima équivalente aux normes applicables dans l'Union Européenne, sont couverts par notre garantie (hors sources lumineuses incandescence ou Eco-Halogène). Le remplacement éventuel ne pourra, en aucun cas, justifier un retard ou un refus à régler nos factures. Seule pourra être retenue la valeur des pièces reconnues défectueuses. Nous ne proposons aucune autre garantie sur les biens livrés, sans préjudice, toutefois, des droits et obligations du client découlant de dispositions légales impératives contraignantes.

Notre responsabilité pour toute autre forme de préjudice est exclue y compris, notamment, les dommages-intérêts supplémentaires, sous quelque forme que ce soit, la réparation de dommages indirects, dommages consécutifs ou préjudices liés à un manque à gagner.

## JURIDICTION EXCLUSIVE

Ces conditions de vente et de livraison sont soumises exclusivement au droit belge et aux tribunaux de commerce de Bruxelles.

L'ensemble des images / photos utilisées dans ce catalogue sont non contractuelles





# Contact

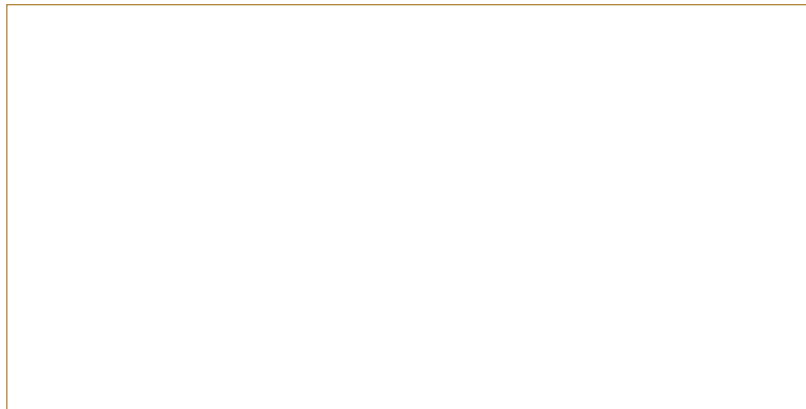

1894

**GIRARD SUDRON**

Créateur de lumière



47, rue des Tournelles, 75 003 Paris.  
Tél. +33 (0)1 44 59 22 20



Chemin du Joran 10, 1260 Nyon.  
Tél. +41 (0)22 369 95 00



Neustrasse 26, D-54413 Grimburg.  
Tél. +49 681 969 890 10



U13 Bentley Court, Finedon Road Ind. Est. Wellingborough,  
Northamptonshire, NN8 4BQ | Tel. + 44 (0)1933 770 550



Girard Sudron Belgique SARL. Rue Van Eyck, 22  
B1000 - Bruxelles, BELGIQUE



Lighting Difusion Italia srl Via Savonarola, 217,  
35137 Padova. Tel. +39 331 5239091

